

INSTRUCTION MANUAL

BS-10S

Swivel Head Metal Cutting Band Saw (415V)
400 x 230mm (W x H) Rectangle

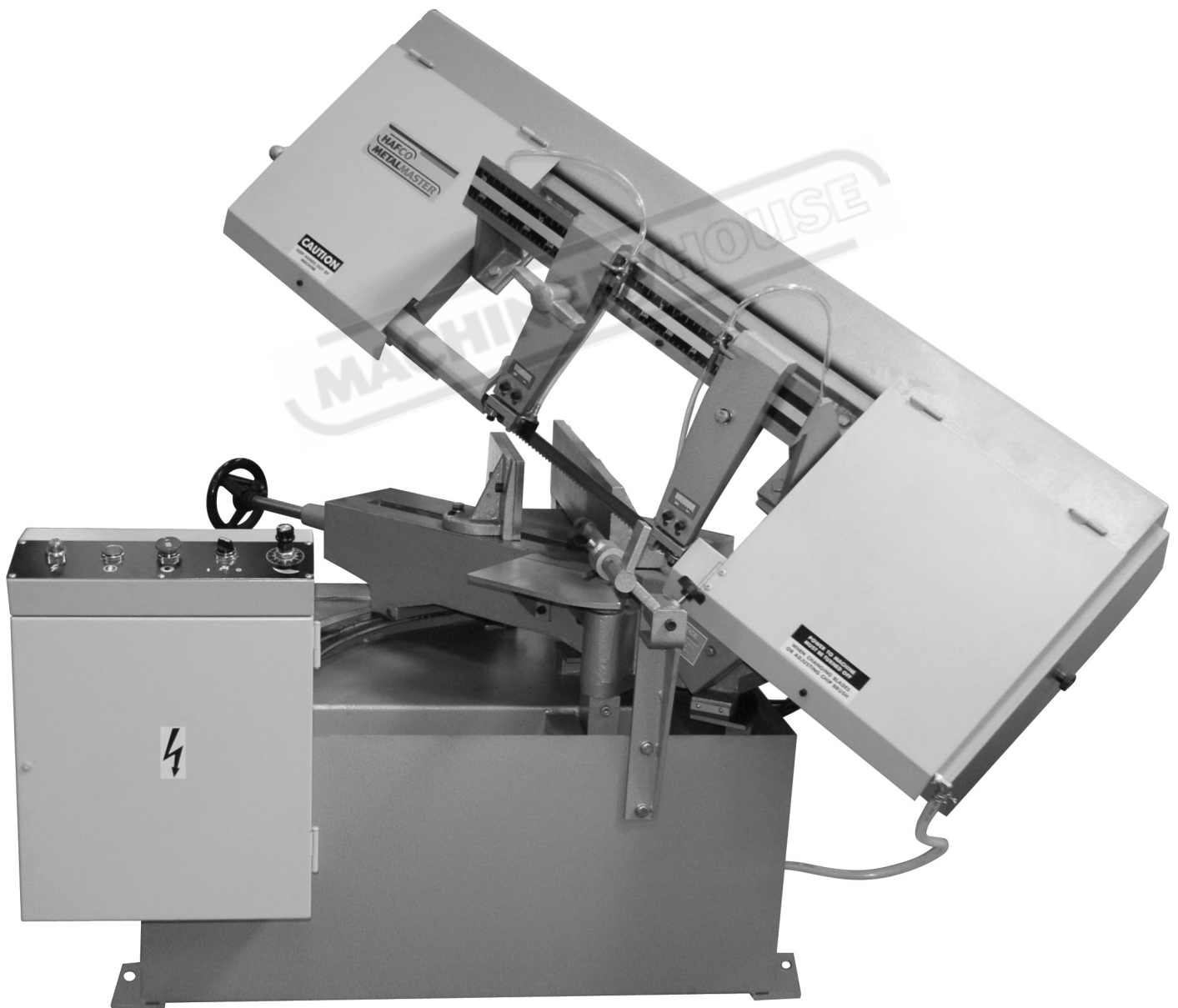

B028

SAFETY

1. Know your band saw. Read the operator's manual carefully. Learn the operation, application and limitation. Realize the specific potential hazards peculiar to this band saw.
2. Use recommended accessories. Improper accessories may be hazardous.
3. Wear proper apparel.
4. Keep unnecessary people away.
 - * Do not overreach or stand on tool.
5. Avoid dangerous environment. Do not use band saw in damp or wet locations. Keep work area well illuminated.
6. Keep work area clean. Cluttered and slippery floors invite accidents.
7. Remove adjusting keys and wrenches from band saw before turning on power.
8. Avoid accidental starting. Make sure switch is off before plugging in power cord.
9. Do not force band saw. It is safer to operate with the cutting rate for which it was designed.
10. Never hand hold the material with saw in horizontal position. Always use the vise, and clamp securely.
11. Keep belt guard and wheel covers in place and in working order.
12. When a workpiece is too long or heavy, support it from the floor.
13. Always remember to switch off the machine when the work is completed.
14. Disconnect power cord before adjusting, servicing and changing blade.
15. Check damaged parts. Before further use of the tool, a guard or other parts that is damaged should be carefully checked. To assure that it will operate properly and perform its intended function.
16. Moving parts should keep in an alignment and binding. Check for breakage, mounting and any other conditions that may affect its operation. Any damaged part or guard should be properly repaired or replaced.
17. Use a sharp blade and keep tool clean for best and safest performance.
18. Safety is a combination of operator's common sense and alertness at all times when the saw is functioning.
19. Maintaining the band saw in top condition is essential for safety.

■ Never wear gloves loose clothing when operating the machine. They may cause danger if they are caught in a running machine.

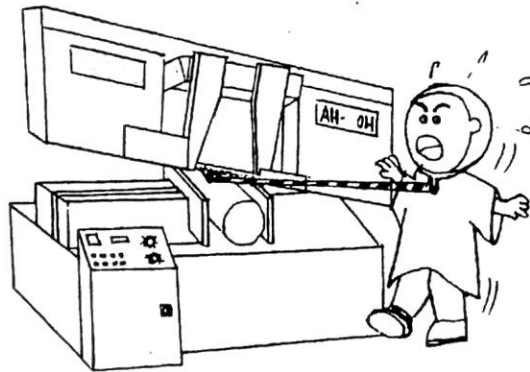

■ Be sure to confirm that the area around the machine is cleared of people and obstacles every time before starting the machine or operation.

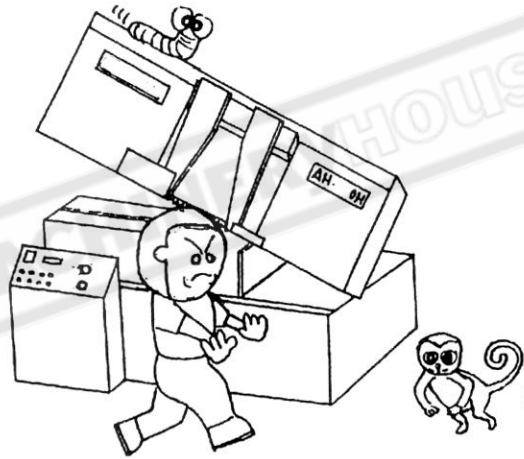

■ Use a water-soluble cutting fluid on this machine. Oil-based cutting fluids may emit smoke or catch fire, depending on the condition of their use.

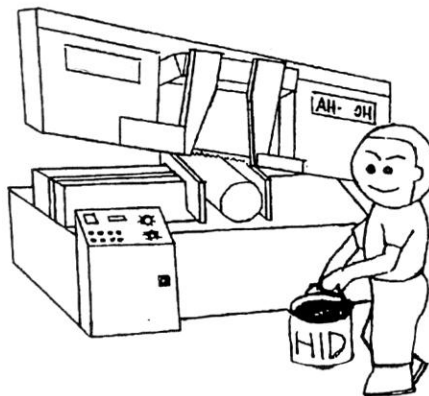

■ Never try to adjust the wire brush on the saw blade or remove chips when the saw blade is running. It is dangerous if hands or clothing are caught by the running blade.



■ Never cut carbon or any other material that produces and disperses explosive dust on this machine. Sparks from motors and other machine parts may ignite and explode the air-borne dust. The machine needs special measures for cutting explosive materials.

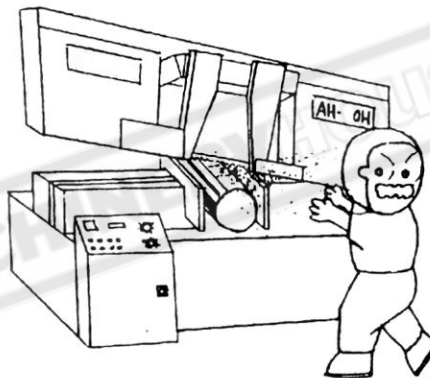

■ Stop the saw blade before you clean the machine. It is dangerous if hands or clothing are caught by the running blade.

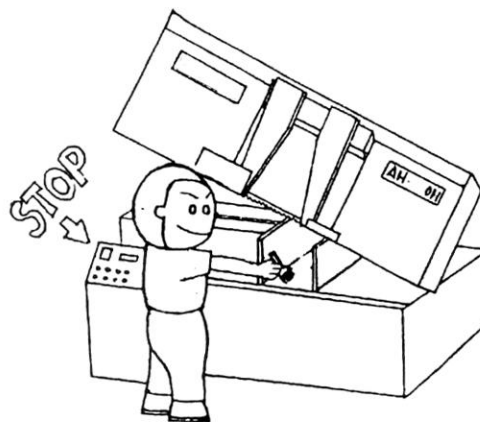

■ Be sure to prohibit any use of fire in the shop, and install a fire extinguisher or other fire control device near the machine when cutting titanium, magnesium, or any other material that produces flammable chips. Never operate the machine unattended when cutting flammable materials.

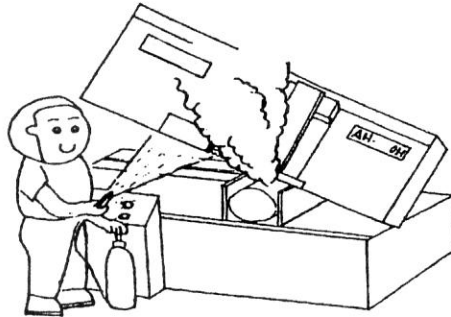

■ Use roller tables on both front and rear sides of the machine when cutting the long work. It is dangerous if the work falls off the machine when the roller tables are not used.

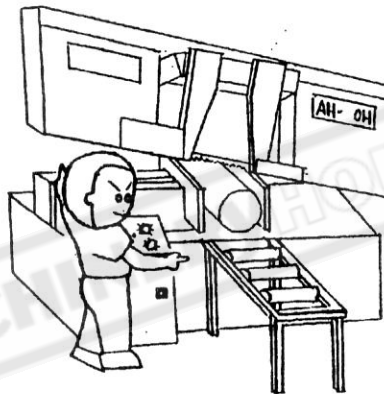

■ Take preventive measures when cutting thin or short pieces from the work to keep them from falling. It is dangerous if the cut piece falls.



■ Never start the saw blade unless it has been confirmed that the work is firmly clamped. If the work is not securely clamped with the vise, pieces will be forced out of the vise during cutting.

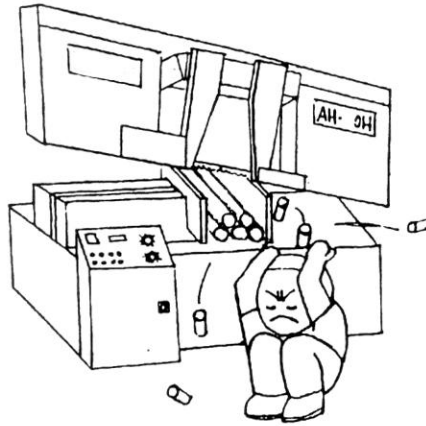

■ Never touch the running saw blade. It is dangerous if your hands or clothing are caught by the running blade.



■ Never step or stand on the roller table. It is dangerous if your foot slips on the rollers and you fall.

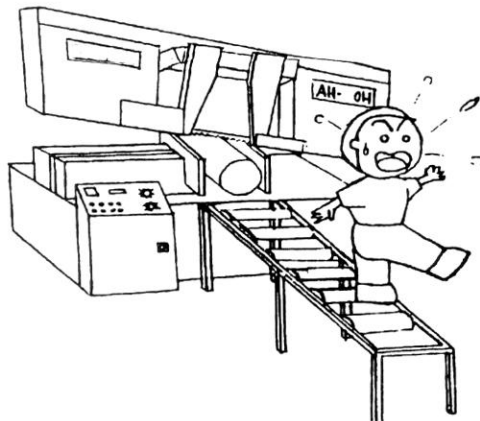

■ Turn off the shop circuit breaker switch before servicing the machine. Then post a sign to inform people that the machine is under maintenance.

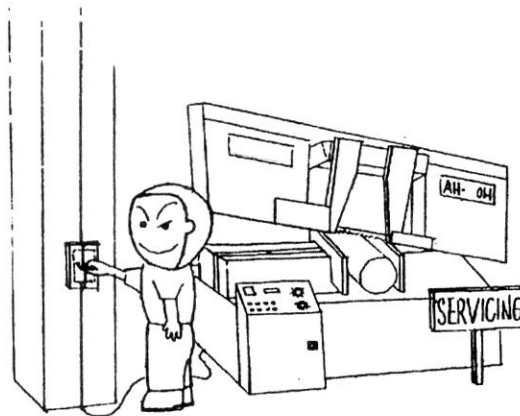

MACHINERYHOUSE



*YO! Richard is my name, Teaching is my game.
Come wit h me, And be a professor.
Bef ore we're done, We'll have some fun
It 's an easy ride... "THE INSTRUCTION MANUAL".*



TABLE OF

Contents

Emotion

Foreward

Safety Rules



Section

1. GENERAL INFORMATION

- 1.1 INTRODUCTION 1-1
- 1.2 SPECIFICATIONS 1-2
- 1.3 THE NOMENCLATURE OF THE PARTS OF THE MACHINE 1-3
- 1.4 NOISE LEVEL 1-5

2. MOVING AND INSTALLATION

- 2.1 INTRODUCTION 2-1
- 2.2 MOVING OF THE MACHINE 2-1
- 2.3 INSTALLATION OF THE MACHINE 2-3
 - 2.3.1 Safety Precautions 2-4
 - 2.3.2 Initial Inspection 2-4
 - 2.3.3 Space required 2-4
 - 2.3.4 Unpacking 2-7
 - 2.3.5 Equipment Furnished 2-7
 - 2.3.6 Installation Procedure 2-7
- 2.4 WORKING CONDITIONS 2-10

3. OPERATING INSTRUCTION

- 3.1 SAFETY PRECAUTIONS 3-1
- 3.2 PREPARATION FOR USE 3-1
- 3.3 CONTROL PANEL 3-2
- 3.4 CHECKLIST BEFORE OPERATING 3-3
- 3.5 OPERATING INSTRUCTION 3-4
 - 3.5.1 Blade Speed Selection 3-4
 - 3.5.2 Speed Adjustment 3-4

3.5.3	Blade Selection	3-5
3.5.4	Cutting Feed Adjustment	3-6
3.5.5	Vise Adjustment	3-7
3.5.6	Irregular Cross Section	3-8
3.5.7	Material stop bracket	3-9
3.5.8	Blade Tension Adjustment	3-10
3.5.9	Levelling of Saw Blade and Bed Horizontal Line	3-10
3.5.10	Automatic Shut-off	3-10

4. ELECTRICAL SYSTEM

5. HYDRAULIC SYSTEM

5.1	INTRODUCTION	5-1
5.2	THE LAYOUT OF THE HYDRAULIC SYSTEM	5-2
5.3	THE HYDRAULIC CIRCUIT	5-2

6. BAND SAW CUTTING - A PRACTICAL GUIDE

6.1	INTRODUCTION	6-1
6.2	BAND SAW BLADE SELECTION	6-1
6.3	SOME SAWING PRACTICES	6-3

7. MAINTENANCE

7.1	MAINTENANCE SCHEDULE	7-1
7.2	STORAGE CONDITIONS OF THE MACHINE	7-2
7.3	DISPOSAL OF THE MACHINE	7-2

8. SYSTEMS TROUBLE SHOOTING

8.1	INTRODUCTION	8-1
8.2	GENERAL TROUBLES AND SOLUTIONS	8-2
8.3	MOTOR TROUBLES AND SOLUTIONS	8-3
8.4	BLADE TROUBLES AND SOLUTIONS	8-4

9. PARTS LIST

APPENDIX

A. Specifications of the Machine	appendix- I
B. Foundation Diagram	appendix- II
C. Accessories of the Machine	appendix- III
D. Maintenance Schedule	appendix- IV

Section 1

GENERAL INFORMATION

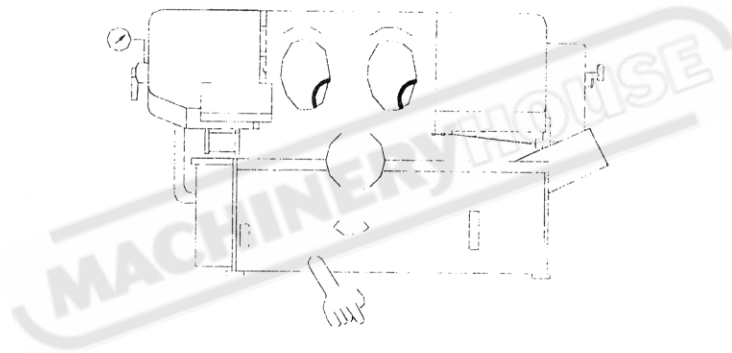

SECTION 1

GENERAL INFORMATION

1.1 INTRODUCTION

COSEN has manufactured bandsaw machines for more than two decades. COSEN is devoted to the research and development of advanced technology while improving the bandsaw production process. A Computer-Aided-Design system has been utilized by COSEN for three years. Also, A computer controlled Management System has been introduced to the Sales and Accounting Department. COSEN continues to hit the target with its Flexible Manufacturing System and expects their products to be the most efficient, convenient, and friendly in this field.

The fundamental design concept of this machine is based on three objectives, **MANUAL**, **EFFICIENT**, and **LOW COST**, therefore, you can find out that only a few hydraulic-controlled and electric-controlled components are used on this machine. However, under the limited cost condition, this machine still has many features as follows:

1) HYDRAULIC FEED

Adjustable hydraulic feed and quick change tension adjustment provide an infinite ranger of cutting pressure.

2) CARBIDE GUIDE

Precision ball bearings combined with carbide faced guides for better square cutting accuracy and stability.

3) QUICK SET UP VISE

Specially designed vise adjustment for quick changes to suit different cutting degrees ranging from 90 ° to 45 ° .

4) TRANSMISSION

Equipped with the best worm gear speed reducer to ensure lasting performance. Worm shaft is hardened and ground. The four speed ranger guarantees trouble free drive.

The COSEN Metal Cutting Band Saw is an ideal tool for the machine shop, metal fabricating shop, school and limited run production work. Its solid construction insures many years of reliability accurate performance.

The nomenclature of the machine parts and the machine specification are shown on next two pages.

1.2 Specification of The Machine

MODEL		MH-1016JA, Manual Band Saw Machine	
MAX. CAPACITY	●(D)	250 mm (10", 90°)	250 mm (45°)
	■ (W×H)	230×230 mm (9"×9", 90°)	150×150mm(45°)
	■(W×H)	230×400 mm (9"×16", 90°)	150×230mm(45°)
SAW BLADE	SPEED	60Hz	23,37,58,93 m/min. (75~305 fpm)
		50Hz	19,31,45,67 m/min. (62~256 fpm)
	SIZE (W×L×T)	3350×25×0.9 mm (132"×1"×0.035")	
MOTOR OUTPUT	SAW BLADE	1.5 kW (2HP)	
	COOLANT	0.1 kW (1/8HP)	
COOLANT	CAPACITY	20 L (5.28 gal. U.S.standard)	
FEEDING	MODE	MANUAL	
	LENGTH	0-3600 mm (0 ~ 141")	
WISE	CONTROL METHOD	STATIONARY & MOVABLE MANUAL WISE	
HEIGHT OF WORK BED	620 MM (24.5")		
NET WEIGHT	600 kgs (1320 lbs)		
GROSS WEIGHT	650 kgs (1430 lbs)		
FLOOR SPACE(L×W×H)	1690×830×710 mm (66.5"×32.7"×28")		
	•Adding width is 1000 or 2000 mm more (with the optional roller table, high 620mm)		
	•The height is 710 mm when saw bow is at horizontal position		
SHIPPING SPACE (L×W×H)	1816×1003×1168 mm (71.5"×39.5"×46")		

* Design and specifications are subjected to change without notice

1.3 THE NOMENCLATURE OF THE PARTS OF THE MACHINE

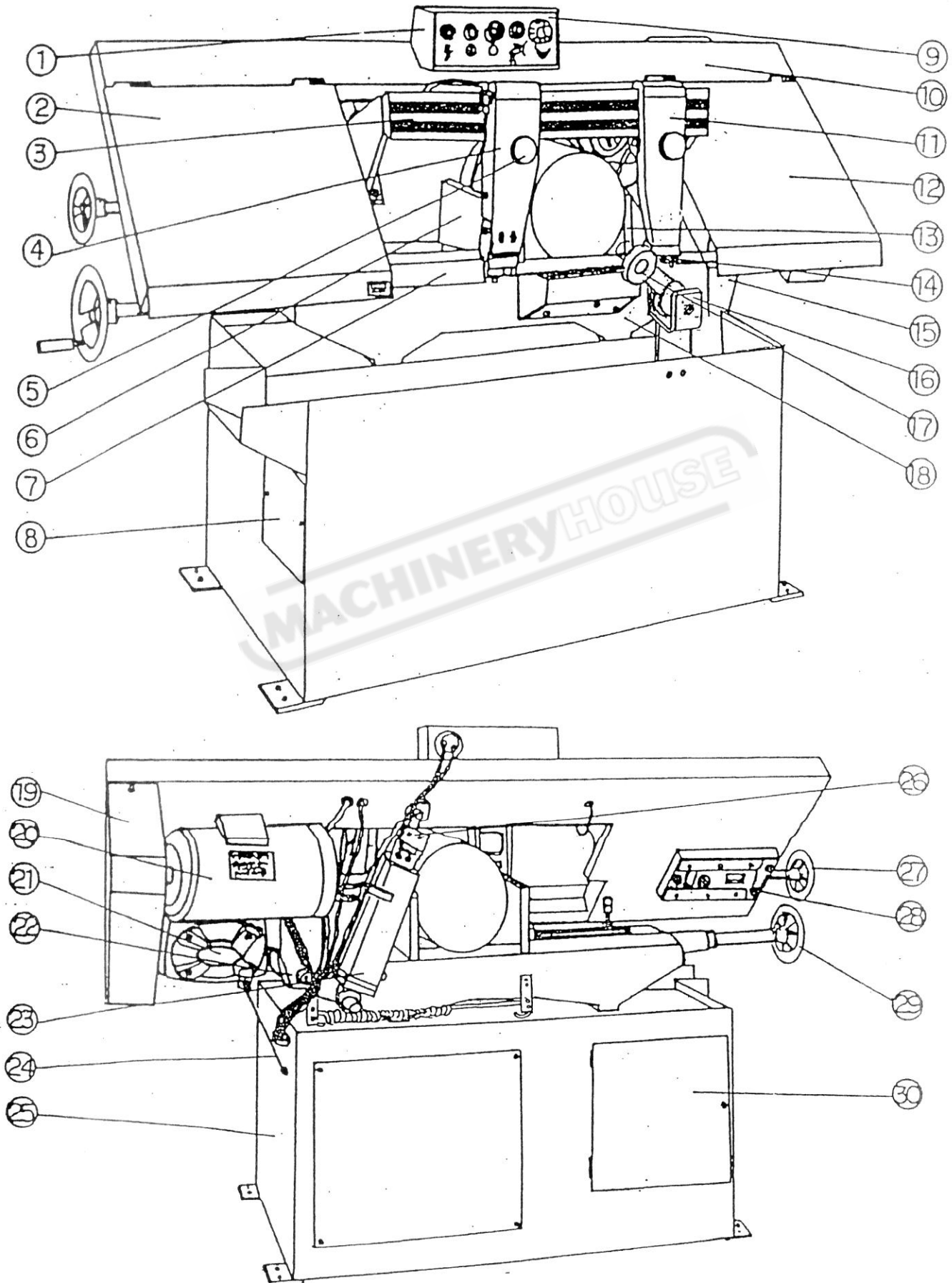

1. Control panel box
2. Idle wheel cover
3. Dovetail slide guide
4. Arm beside idle wheel
5. Arm fixing handle
6. Movable vise jaw
7. Blade guard
8. Pump cover
9. Control panel
10. Saw bow
11. Arm beside drive wheel
12. Drive wheel cover
13. Fixed vise jaw
14. Blade guide roller
15. Blade guard
16. Stopper
17. Depth bar (Length bar)
18. Bed
19. Cover for belt
20. Motor
21. Transmission
22. Saw bow bracket
23. Hydraulic cylinder
24. Feed tension spring
25. Basement
26. Limit switch
27. Tension handle
28. Idle wheel tension adjustment slide
29. Vise hand wheel
30. Electric cabinet door

1.4 NOISE LEVEL

Noise is a very important environmental concern at the work site.

- Excessive exposure to high levels of noise may cause injury to the hearing, but the sensitivity to hearing loss varies between individuals and must be taken into account in specifying an allowable limit for noise exposure.
- A level of 90 dBA is widely accepted as a criterion for 8h/day exposure to steady-state broad-band noise.
- The unprotected ear should not be exposed to noise levels higher than 120 dBA.

The noise of the machine comes from the following sources,

1. Saw blade during cutting
2. Wire brush unit
3. Chip conveyor unit
4. Speed reducer
5. Hydraulic motor / pump
6. Belt transmissions variable speed motors
7. Blade motor
8. Drive wheels
9. Parts not secured tightly causing mechanical vibration

The noise level of this machine has passed noise testing criterion (under 70 dBA). Please refer to the system troubleshooting in section 10 if abnormal noise occurs.

Section 2

MOVING AND INSTALLATIONS

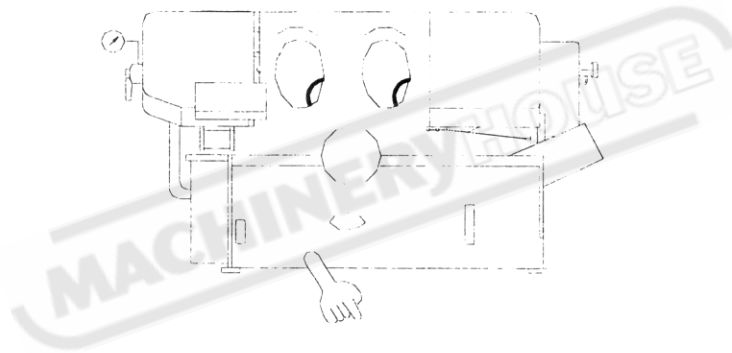

SECTION 2

MOVING AND INSTALLATION

2.1 INTRODUCTION

Your machine is composed of three main systems, named
Mechanical System,
Hydraulic System, and
Electrical Control System.

Please read the manual carefully to obtain a thorough knowledge of the machine and its moving & installation. Correctly operate the machine as described in the manual to prevent personal injuries and machine damage.

Do not operate the machine by guesswork. Keep this manual at hand and refer to it whenever you are not sure of how to perform any of the procedures.

2.2 MOVING OF THE MACHINE

As far as the moving of the machine is concerned, please follow the **carrying** and **cleaning** method to keep your machine in the best working condition. You can choose any one method as following to move your machine:

A. CARRYING:

1. Use crane to place

Carry the machine to its location by using a crane and a wire rope sling that can fully withstand the weight of the machine(your machine weight about 650 Kg). Apply the wire rope sling to the lifting hooks at the rear of the front vise slide and to the rear end of the machine. Slowly lift the machine while taking care so that the machine is not shocked and that the wire rope does not interfere with the saw-head.

MOVING AND INSTALLATION

Section 2

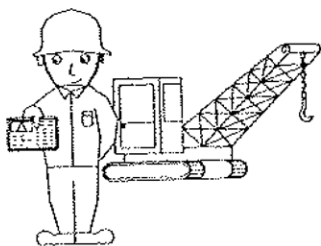

- ✓ • A qualification license to crane is necessary to move your machine.

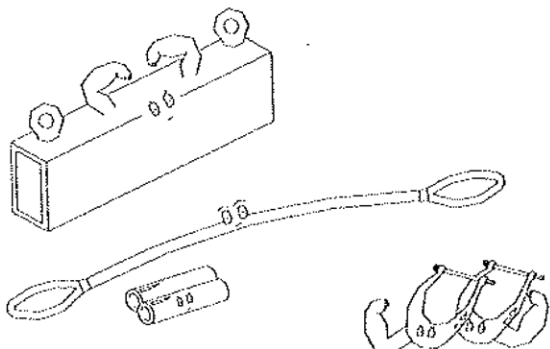

- ✓ • Use proper tools and wire rope slings to move your machine.

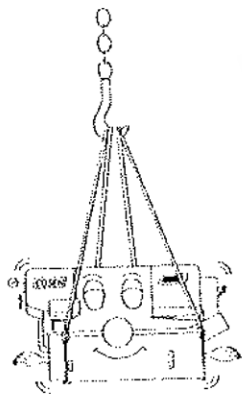

- ✓ • Apply the wire rope sling to the lifting hole at the rear of the front vise slide and the rear end of the machine. Keep the machine balance while moving the machine up.

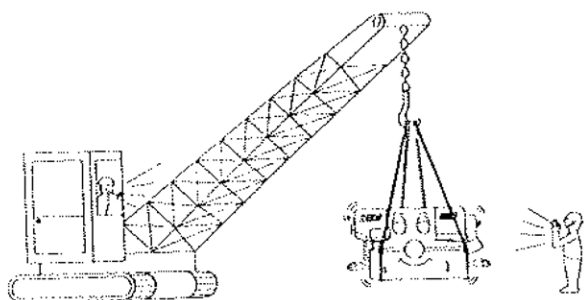

- ✓ • When working together with more two people, take care of each other to avoid dangerous moving.

MOVING AND INSTALLATION

Section 2

2. Use forklift to place

Most of the users choose this method to move their machines.

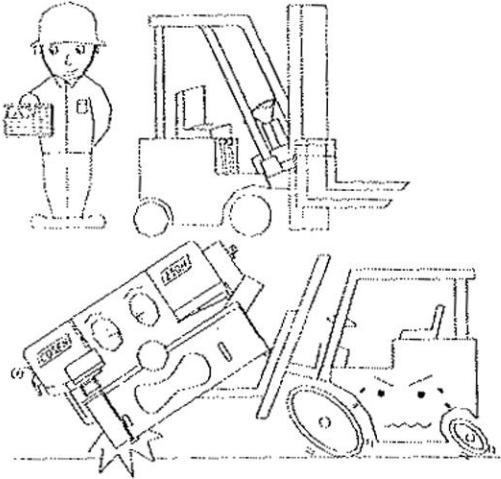

- ✓• A qualification license to forklift is necessary to move your machine.

- ✓• Use adaptable capability of forklift.

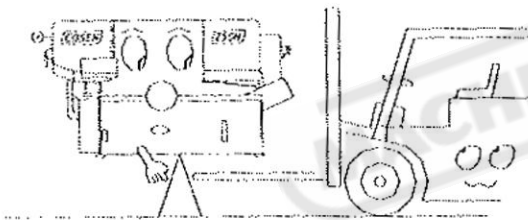

- ✓• Keep balance of your machine.

3. Use rolling cylinder to place

You can use this method to move your machine when it is in the small machine shop .

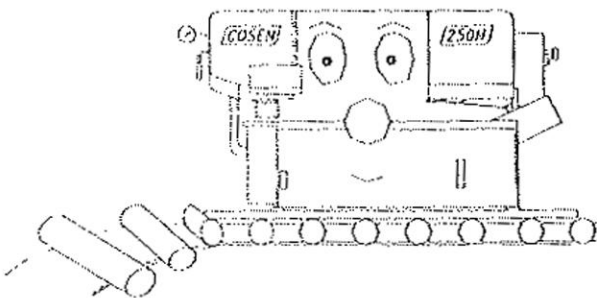

- ✓• Use adaptable compressive strength of the wooden stand material.

- ✓• Use adaptable compressive strength of the rolling cylinder material.

MOVING AND INSTALLATION

Section 2

B. CLEANING

After the machine has been spotted on the designated position, remove the rust-preventive grease with wiping cloth dampened with cleaning oil or kerosene. Apply machine oil to the machine surfaces that are susceptible to rusting.

- ☛ Do not remove the rust-preventive grease with a scraper or the like. Do not wipe the painted surfaces with solvent.

2.3 INSTALLATION OF THE MACHINE

2.3.1 Safety Precautions

Surroundings

- ✓ • Keep the machine away from the sun light.
- ✓ • Keep the temperature of the surroundings at 5~40°.
- ✓ • Keep the humidity of the surroundings at 30%-95" (without condensation) to avoid dew on electric installation and machine.
- ✓ • Keep enough space between your machine and others machines to avoid the vibration interfering to each other.
- ✓ • Do not install your machine on an uneven ground foundation.
- ✓ • Keep your machine away from the water or heavy dust.

Power Supply

- ✓ • Supply voltage: 90 %- 110 % of nominal supply voltage.
- ✓ • Source frequency: 99 %- 101 % of nominal frequency.
- ✓ • Do not use the same power supply together with electric spark machining, electric welder. to avoid unstable voltage.
- ✓ • The independent and direct power supply is a suggestion.
- ✓ • Use correct capacity of electric power supply.
 - ☛ Limit the supply voltage variations to within $\pm 10\%$
- ✓ • Earth the machine properly with an independent wire.

2.3.2 Initial Inspection

1. Check the model of your machine and the instruction manual.
2. Check the equipment or tools being furnished.
3. Check the outlook of your machine to make sure that your machine was shipped or transportation in a good condition.

2.3.3 Space Required

Keep enough spaces for material loading and unloading, operation, inspection and maintenance of the machine as the following figures,

MOVING AND INSTALLATION**Section 3****Required Floor Space (without Roller Table)**

NO.	NAME
1	Machine body
3	Speed Change Device
4	Main Motor
5	Sizing Rod

UNIT : mm

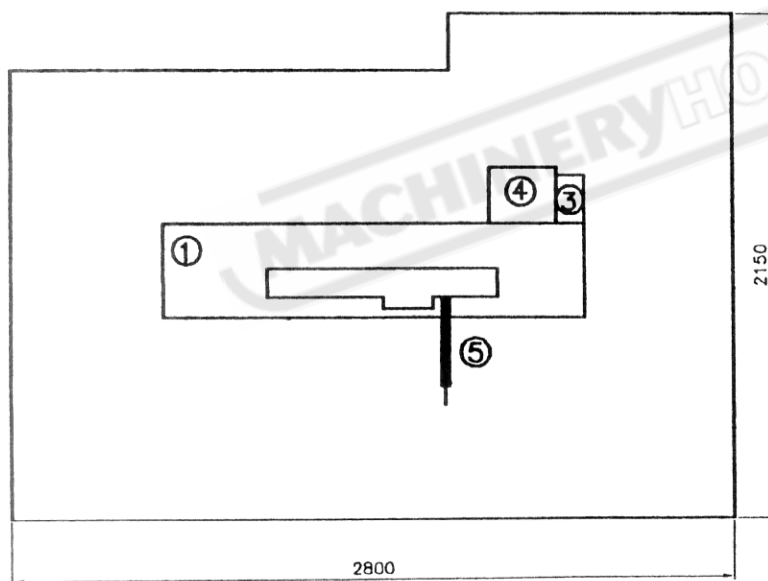

MOVING AND INSTALLATION**Section 3****Required Floor Space (with Roller Table)**

NO.	NAME
1	Machine Body
3	Speed Change Device
4	Main Motor
5	Optional Roller Table(1M)

UNIT : mm

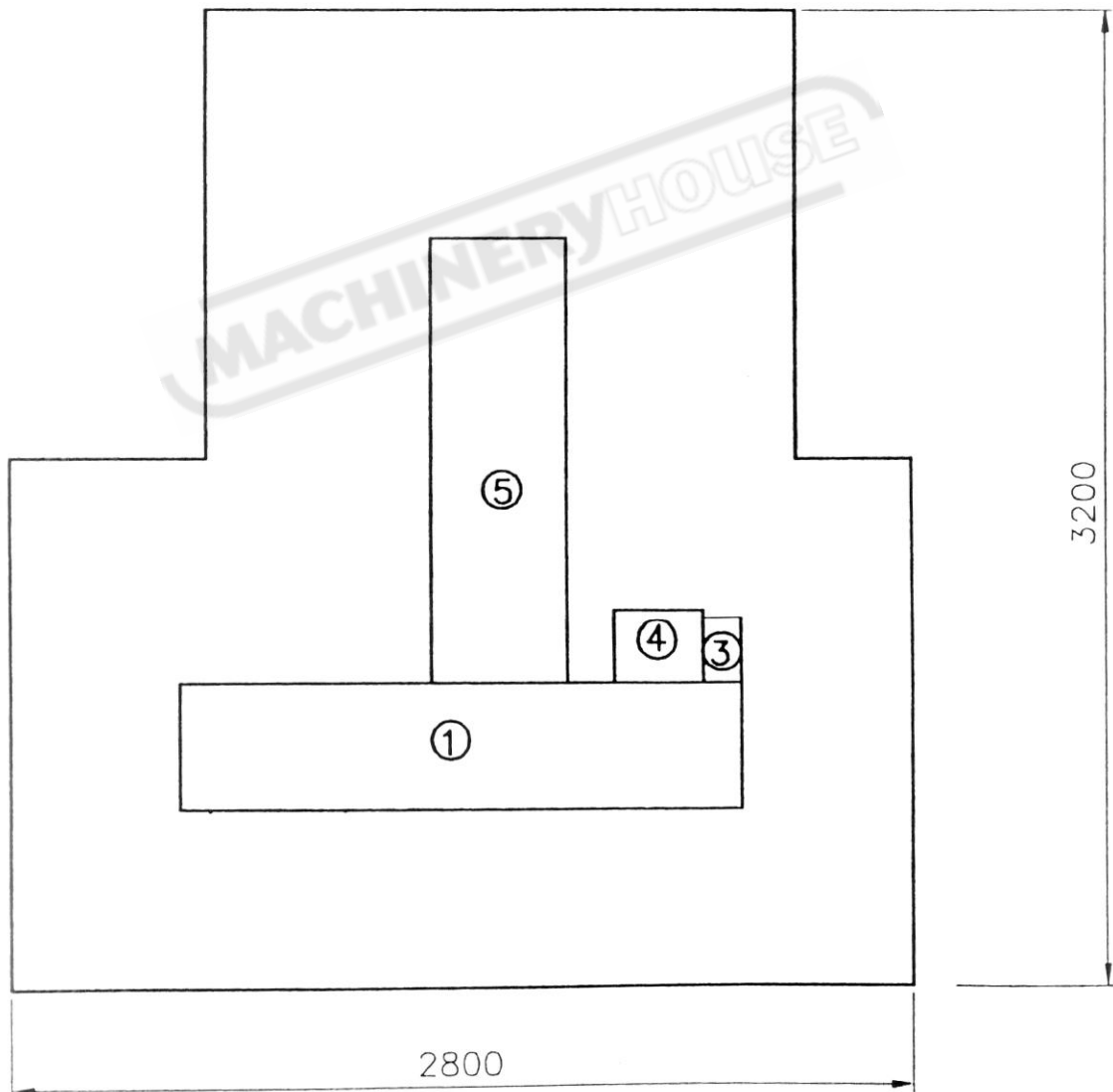

MOVING AND INSTALLATION

Section 2

2.3.4 Unpacking

- After the machine has been properly positioned, remove the shipping bracket carefully by screw driver and proper tools to avoid being hurt by the snails.
 - Unpack your machine carefully. Do not damage the machine surface paint.
- ☛ Be sure to retain this bracket so that it can be used again in the event that your machine must be relocated.

2.3.5 Equipment Furnished

Your machine has a set of tools to do the maintenance as following,

1. Tool box	1 pc
2. Grease gun	1 pc
3. Screw drive(+, -)	2 pcs
4. Open end spanner	3 pcs
5. Hexagon wrench	1 set
6. Chip filings spade (with manual type only)	1 pcs
7. Operation & parts book	1 pcs

3.3.6 Installation Procedures

Your machine is more easy installing than other brand's type. Following this manual, you can do yourself step by step. The major machine function for setting up as following: fixing the machine on the floor, machine leveling, installation of feed roller, cutting fluid supply, hydraulic oil supply, electrical connection

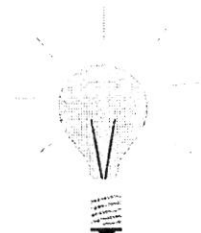

○ Anchoring the machine on the ground foundation

1. For best performance, the band saw has to be anchored on a solid foundation. The ground foundation must have a carrying capacity of approximately 2.0 ton (including: material weight).
2. It is recommended that the shock absorption pads be installed when levelling.
3. If a crane is used to lift the machine, ensure that the lifting cable is properly attached to the machine.
 - ☛ Be careful to protect the machine from impact or shock during this procedure. Machine weight: 650 kg(1430lbs).

MOVING AND INSTALLATION

Section 2

○ Machine leveling

- Place spirit levels on the vise slide plates and the work feed table, and adjust the left-and-right and fore-and-aft level of the machine with leveling bolts.
- The fore-and-aft level should be adjusted rightly. The level of the rear for the machine is approximately 25 mm(1 in.) higher than the level of the front end. This will allow the proper return of the cutting fluid for working. The illustration as show as Following:
 - Be sure to ascertain that all leveling bolts evenly support the weight of the machine.

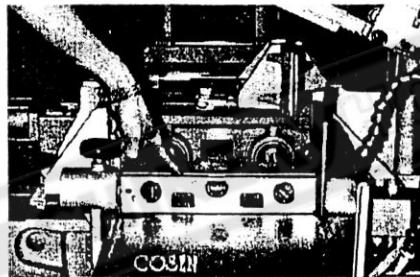
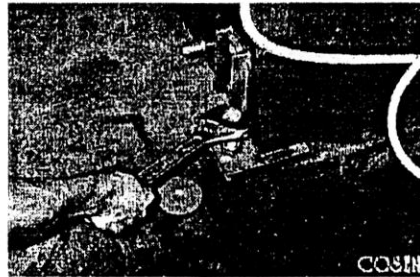

* Use a level gage to make sure that the platform is flat and even at all angle.

○ Installation of feed roller

If you plan to cut long workplaces, please arrange the roller table and roller stand behind the machine.

- The roller table and roller stand should be level with the machine itself.

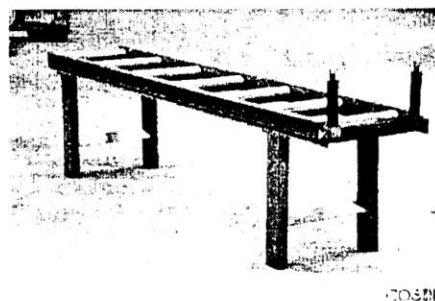

MOVING AND INSTALLATION

Section 2

○Cutting fluid supply

Use proper cutting fluid mixture. If Shell Dromus BS or Shell Lubricool Yellow Cutting Fluid is used, the ratio of cutting fluid to water should be approximately 1:15~1:20. Check the sight gauge to ascertain the fluid level in the tank. Tank capacity: 20 liters(5.28US gal)

○Hydraulic oil supply

Open the filler cap. Please fill the hydraulic oil tank with the hydraulic oil furnished with the machine. Check the sight gauge to ascertain the oil level in the tank.

○Electrical Connections (Power Requirement)

- Open the electrical enclosure door and connect the power supply cable to the circuit breaker(N.F.B.) terminals that are indicated by the arrow in illustration as following:
- Be sure to connect the ground cable to the ground terminal. The power supply to your machine should agree with the wiring voltage that is indicated on the label attached to the electrical enclosure.
- If the power line voltage is changed, change the wiring of the transformer and motors, and reset or replace the thermal relays as shown as following:

- ➡ 220V- 50Hz
- 380V- 50Hz
- 415V- 50Hz
- 440V- 50Hz

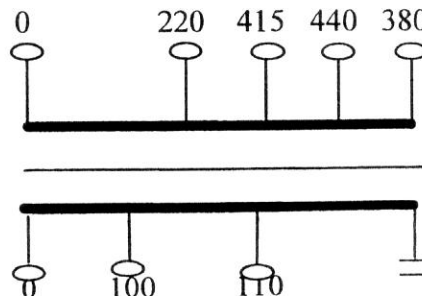

○Installing Fire Control Device

Install a fire extinguisher or other fire control device in the shop.

MOVING AND INSTALLATION

Section 2

2.4 WORKING CONDITIONS



For safety in operating working, we recommend you as following:

- Your should work in light clearly for working site.
- To avoid operator falling down, please keep dryness on the floor.
- To avoid the dust that comes from another machine making affect electrical control facilities.
- Except operator, please do not let people near your machine for safety.

MACHINERYHOUSE

Section 3

OPERATION INSTRUCTIONS

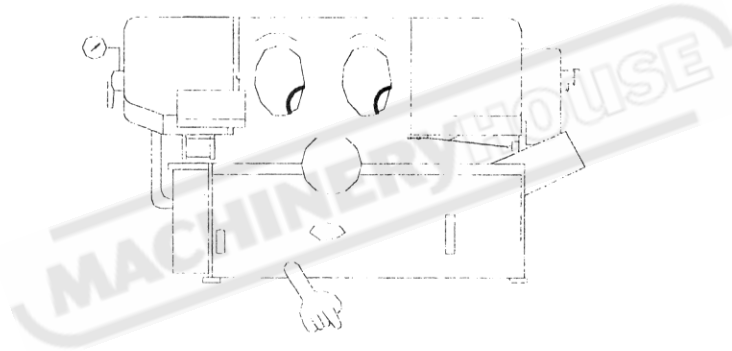

OPERATING INSTRUCTION

Section 3

SECTION 3

OPERATING INSTRUCTION

3.1 SAFETY PRECAUTIONS

For your safety, please read and understand instruction manual before you try to operate your machine. The operator should always follow the guidelines:

- ✓ • The machine only be used according to its destined purpose.
- ✓ • Do not wear gloves, neckties, jewelry, long hair or loose clothing.
- ✓ • For eye protection, you choose protection glasses that it is our suggestion.
- ✓ • Check blade tension and adjust blade guides before starting out.
- ✓ • Always clamp stock firmly in place before cutting and use auxiliary support for long material.
- ✓ • Do not remove jammed or cut-off pieces until blade has stopped.
- ✓ • Keep fingers out of path of blade.
- ✓ • Guards should be in place and used at all times.
- ✓ • Disconnect machine from power source before making repairs or adjustments.
- ✓ • Protective gloves should be worn for band saw changes.
- ✓ • Do not operate while under the influence of drugs, alcohol or medication.
- ✓ • Please do not leave the machine with eyes in any operating.
- ✓ • Please put utility cart or the warning signal to stop people coming up.

3.2 PREPARATION FOR USE

The selection of an appropriate saw blade and cutting method is important in cutting the work safely and efficiently. Select an appropriate saw blade and cutting method by fully considering the work to be cut and the requirements of your job(such as cutting accuracy, cutting speed, economy, and safety control).

Cutting method:

If you choose dry cutting and low speed of saw blade, the chips may accumulate in machine parts and may cause the operation or insulation failure of the machine. We suggest you choose wet cutting in any time to avoid machine damage.

Cutting unknown materials:

Before cutting an unknown material, consult the supplier of the material, burn a small amount of chips from the material in a safe place, or follow any other procedure to check to see if the material is flammable or not.

➤ Never leave the machine with eyes during the cutting operation.

Cutting oil:

If you do not care economic budget, you can try oil-based cutting fluids. We always suggest you to use water-soluble cutting fluids. Following is the comparison table of the water-soluble cutting fluid,

OPERATING INSTRUCTION**Section 3****Advantage and Disadvantage of the water-soluble cutting fluid**

Advantage	Disadvantage
Have high cooling effect	Remove paint
Not flammable	Lose rust protection effect when deteriorated
Economical	Foam
Do not require cleaning of cut products(especially when soluble)	Putrefy
	Decline in performance, depending on quality of water used for dilution

If Shell Dromus BS or Shell Lubricool Yellow Cutting Fluid is used, the ratio of cutting fluid to water should be approximately 1:15~1:20. Check the sight gauge to ascertain the fluid level in the tank. Tank capacity: 20 liters(5.28 gal.)

☛ Never work with pure water only.

3.3 CONTROL PANEL

Six functions are controlled by the six electric gears on the control panel at top position of the electric box, which include

- A) Power Light
- B) Operation Button
- C) Emergency stop button
- D) Coolant Supply Switch
- E) Cutting pressure control

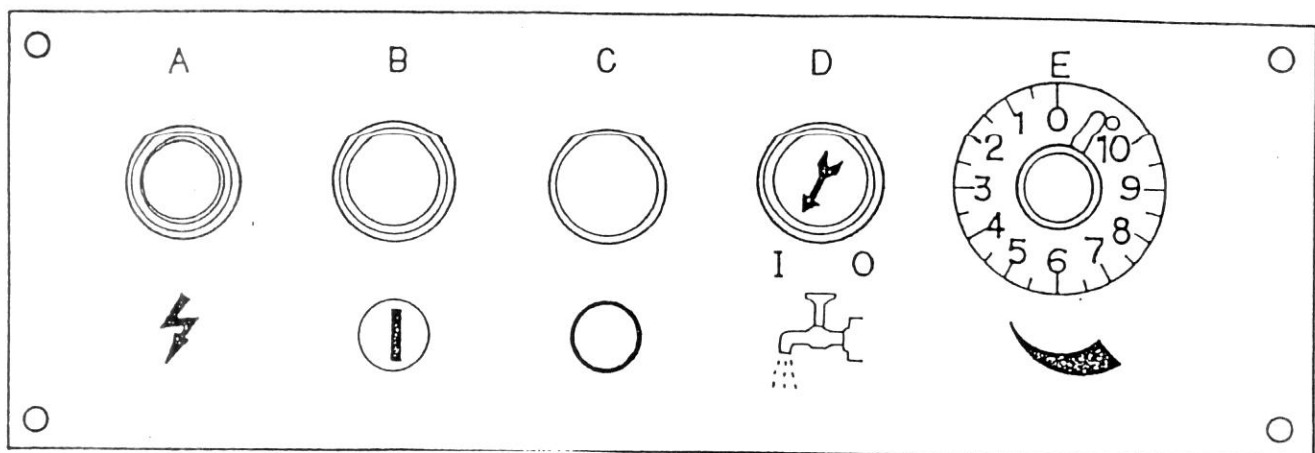

and the positions of these six electric gears are shown on the next page. Following is the description of functions of these six gears.

OPERATING INSTRUCTION**Section 3****A) Power Lamp**

This lamp will be lit when the machine power plug is connectd to the elcteric power of the working shop.

B) Operation Button

When this button is depressed, the saw blade motor starts immediately.

C) Emergency Stop Button

When this button is depressed, all of the machine operations stop immediately.

D) Coolant Supply Switch

When this switch is set at "I", the cutting fluid pump operates and the cutting fluid will be injected; on the contrary, when this switch is set at "O", the cutting fluid pump stops and cutting fluid supply will be terminated.

E) Flow Control Valve

When this control knob is turned counterclockwise, the cutting force of the saw blade increases; when this knob is turned clockwise, the cutting force decreases.

NOTE The saw will stop automatically when the material has been cut through.

3.4 CHECKLIST BEFORE OPERATING

- 1) Make sure the teeth are pointing in the right direction.
- 2) Band should be properly seated on the wheels after applying the correct tension.
- 3) Set blade holder guides for approximate .003 to .005 inch clearance between the guides and blade.
- 4) Check for slight clearance between back up rollers and back of blade.
- 5) Move guides to the operator's position as closely as possible.
- 6) Select proper speed and feed.
- 7) Material should be securely held in vise.
- 8) Coolant should be turned on, if required.
- 9) Do not start cut on a sharp edge.
- 10) Keep machine lubricated.



OPERATING INSTRUCTION

Section 4

3.5 OPERATING INSTRUCTION

WARNING

1. WHEN READY TO CUT, MAKE SURE “SWITCH” IS **OFF** BEFORE PLUGGING IN “POWER CORD”.
2. DO **NOT** APPLY EXTRA FORCE TO THE SAWHEAD DURING CUTTING PERIOD.
3. DO **NOT** CONNECT POWER CORD TO POWER SOURCE UNTIL THE FOLLOWING INSRTRUCTIONS ARE CLEARLY UNDERSTOOD .

3.5.1 SPEED SELECTION

Blade speed selection should be determined according to the material to be cut. The following chart is for general reference only.

Material	Speed		Pulley Groove Used	
	50 Hz	60 Hz	Motor Pulley	Saw Pulley
High speed alloy, stainless and heavy cross section material	57	68	smallest	large
Tool, Stainless Steel, Alloy Steel and Bearing Bronze	100	120	small	medium
Case Iron, Mild Steel, Hard Brass and Bronze	164	196	medium	small
Plastic, Copper, Soft Brass, Aluminum and other Light Materials	277	330	large	smallest

Some materials due to manufacturing processes, such as certain types of cast iron pipe or materials containing certain types of welding, can not be cut on this machine.

NOTE A GENERAL RULE TO FOLLOW IS, “IF THE MATERIAL CAN BE CUT WITH A FILE, IT CAN BE CUT ON THIS BANDSAW.”

3.5.2 SPEED ADJUSTMENT

This unit is designed to adjust the blade speed which ranges from 20 m/min to 85 m/min (70 ft/min to 280 ft/min). Turn the handwheel clockwise to decrease the blade speed; turn the handwheel counterclockwise to increase the blade speed. Please refer to the cutting data in this manual before changing the blade speed.

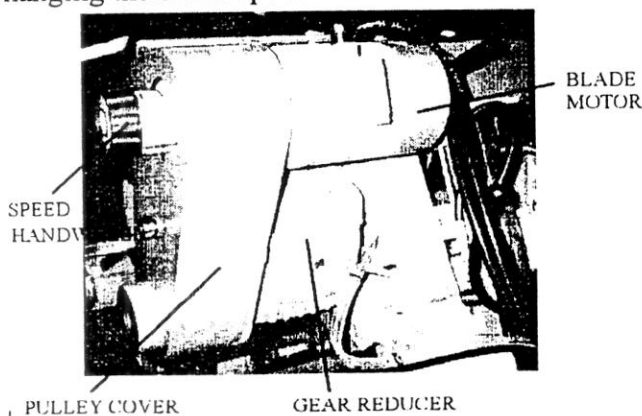

BLADE SPEED/MARK	0	1	2	3	4	5	6	7	
M/MIN	50HZ	20	24	30	36	41	53	62	71
	60HZ	24	30	37	44	50	65	76	87
FT/MIN	50HZ	66	79	98	118	135	174	203	233
	60HZ	79	98	121	144	164	213	249	285

OPERATING INSTRUCTION

Section 3

The general procedures of speed swap are shown as the following steps,

1. Remove the pulley cover.
2. Loosen the lock handle, as shown in Fig. 1
3. Position belt in proper groove according to the speed selection chart being attached on the pulley cover.
4. Apply tension to belt and tighten lock handle.

NOTE

THE PROPER TENSION IS, 1/2 INCH DEFLECTION OF BELT WHEN APPLYING MODERATE PRESSURE ON THE BELT BETWEEN THE PULLEYS.

5. Replace pulley cover.

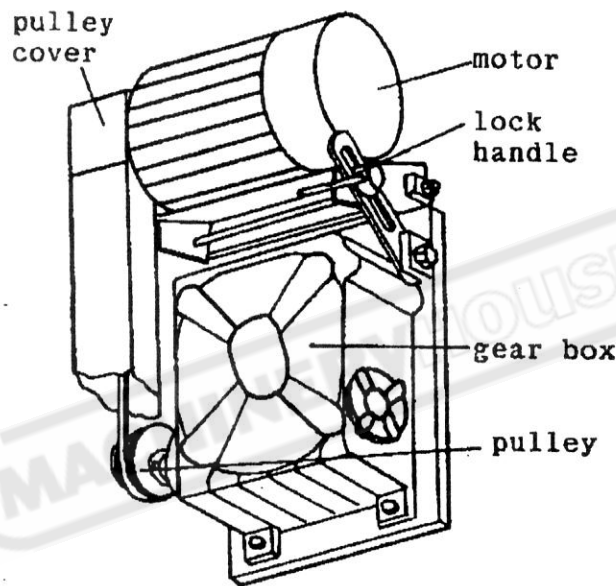

Fig. 1. Speed Swap Configuration

3.5.3 BLADE SELECTION

For best result, the correct number of teeth on the workpiece is of importance. The 3-6-12-24 rule can be applied to the mild materials while the 6-12-24-48 rule can be applied to the hard materials. At least two teeth must be kept in cutting area during cutting period, as shown in Fig.2. The finer tooth blade should be used when cutting thin sections and harder materials while the coarse teeth should be used when cutting large work and tough gummy metals.

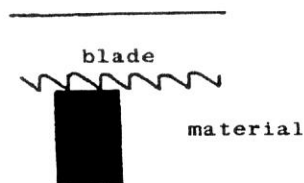
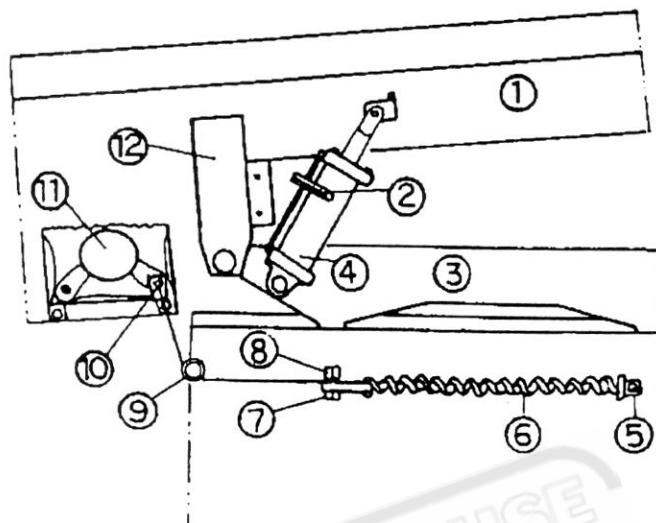

Fig. 2 Two Teeth On the Cutting Material

OPERATING INSTRUCTION**Section 3****3.3.4 CUTTING FEED ADJUSTMENT**

The hydraulic cylinder and the feeding tension spring in Fig. 3 should be adjusted together to obtain the correct cutting feed rate for any desired feed pressure while forcing the blade downward into the material.



- | | |
|------------------------|--------------------------|
| 1. Saw Bow | 7. Lock Nut |
| 2. By-Pass Valve | 8. Adjustment Screw |
| 3. Bed | 9. Wire Rope Guide Wheel |
| 4. Hydraulic Cylinder | 10. Lock Screw |
| 5. Bracket | 11. Gear Box |
| 6. Feed Tension Spring | 12. Screw Bow Bracket |

Fig. 3 Cutting Feed Adjustment Mechanism

NOTE**RATE OF CUTTING FEED**

- a. Proper rate of cutting feed is important. Excessive pressure can break the blade or stall the saw, on the contrary, insufficient pressure rapidly dulls the blade. The hydraulic cylinder regulates the rate at which the blade is lowered into the material being cut. Adjusting the "Flow Control Valve" provides an infinite choice for rate of cutting feed.
- b. If the workpiece thickness is smaller than 2mm, please turn the knob of the flow control valve to 1-2; if the workpiece thickness is bigger than 3 mm, set the knob to 3-4.
- c. If the sawhead is forced downward by manually extra force while doing the adjusting or setting up work, the hydraulic cylinder will be damaged due to its internal By-Pass Over-Ride feature. (**CAUTION**: By-Pass Valve has been properly adjusted before shipping out and please DO NOT reset it.)
- d. While settling the cutting material, the sawhead can be held at the middle position of the whole rising distance by turning the flow control valve to the zero position.

OPERATING INSTRUCTION

Section 3

3.5.5 VISE ADJUSTMENT

WARNING WHEN CUTTING HORIZONTALLY, ALWAYS USE THE VISE TO HOLD THE WORKPIECE. DO NOT HOLD THE WORKPIECE BY HANDS.

Clamp material securely by turning vise hand wheel clockwise. The vise allows great flexibility in cutting by setting the No. 1 position in Fig. 5, the cutting at any degree is possible by adjusting the fixed and movable vise jaw. The vise can be moved up to 45°, which is the No. 2 position in Fig. 5.

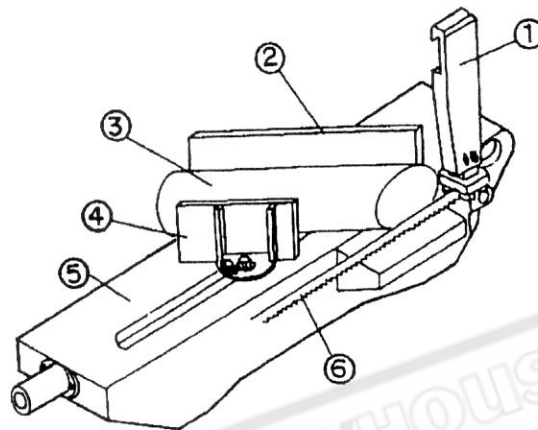

- | | |
|--------------------|---------------------|
| 1. Right Guide Arm | 4. Movable Vise Jaw |
| 2. Fixed Vise Jaw | 5. Bed |
| 3. Material | 6. Blade |

Fig. 4 Vise Adjustment for Miter Cutting

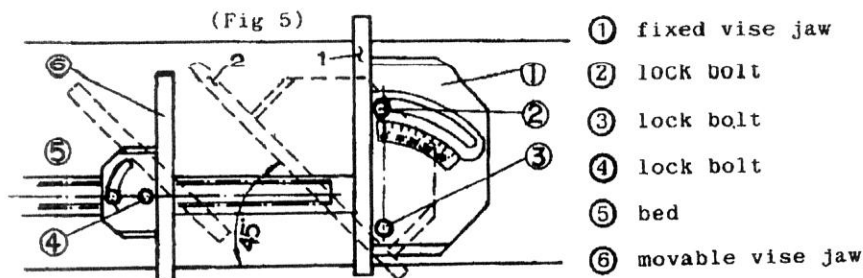

Fig. 5 Vise Adjustment for 45° Miter Cutting

OPERATING INSTRUCTION**Section 3****NOTE****a. 45° MITER CUTTING**

- 1) Move right guide arm (No.1 in Fig. 4) to the end of dovetail guide.
- 2) Lift the saw bow up to the maximum vertical position.
- 3) Loosen the two lock bolts (No. 2 and No. 3 in Fig. 5) of the fixed vise jaw, then adjust the fixed vise jaw 45° against saw blade by an accurate square instrument (Fig. 6). Tighten the two lock bolts.
- 4) Clamp the cutting material by the movable vise jaw (No. 4 in Fig. 4)

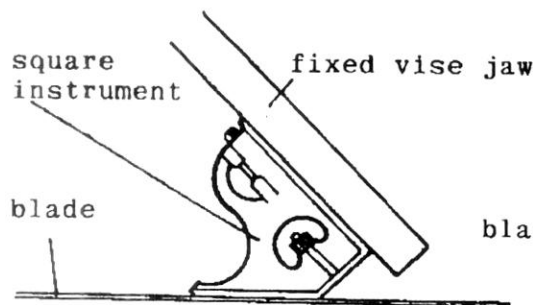

Fig. 6 45° Miter Cutting

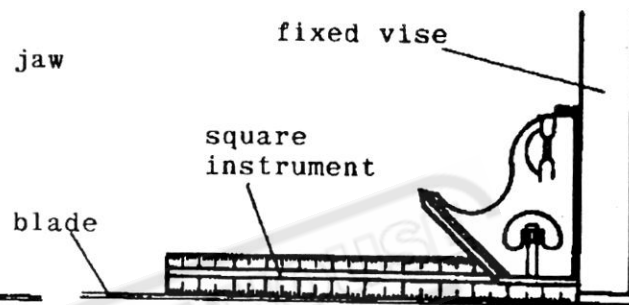

Fig. 7 90° VISE REPOSITIONING

b. 90° VISE REPOSITIONING

When repositioning the vise for 90° cutting, check squareness by placing an accurate square instrument against the fixed vise jaw and alongside the saw blade, as shown in Fig. 7.

3.3.6 IRREGULAR CROSS SECTION

If the cross section of the cutting material is irregular, make sure that the cutting edge is a surface but not a sharp corner, in other words, arrange the workpiece at the position that the teeth on the cutting edge are as many as possible, as shown in Fig. 8.

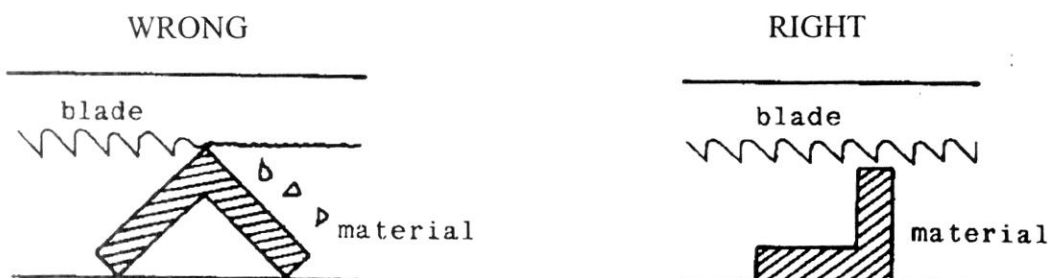

Fig. 8 Cutting of the Irregular Cross Section

OPERATING INSTRUCTION

Section 3

4.5.7 MATERIAL STOP BRACKET

1. Set up the Depth Bar and tighten the Set Screw, as shown in Fig. 9. (Originally the depth bar is not installed on the machine for the safety consideration of shipping)
2. Lift the saw bow and clamp the material, then lower down saw bow to the position that the clearance between the saw blade teeth edge and the material top point is about 1 mm.
3. Measure the desired cutting length.
4. Loosen the Fastening Bolt (No. 3 in Fig. 9).
5. Set the Stopper (No. 6 in Fig. 9) to a position that the end of the stopper is in front of the end of the material.
6. Tighten the Stopper in the Bracket (No. 4 in Fig. 9) by using the Stopper Handle (No. 5 in Fig. 9)
7. Move the Stopper Bracket toward the material and touch the end surface, then tighten the Fastening Bolt.

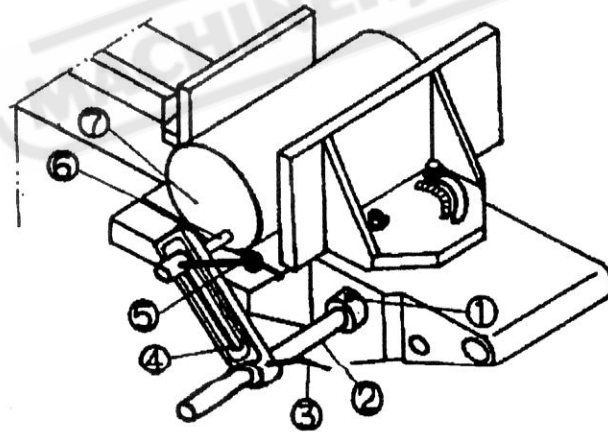

- | | |
|--------------------|------------------------------|
| 1. Set Screw | 5. Stopper Handle |
| 2. Depth Bar | 6. Stopper |
| 3. Fastening Bolt | 7. Front End of the Material |
| 4. Stopper Bracket | |

Fig. 7 Material Stop Bracket Mechanism

OPERATING INSTRUCTION

Section 3

3.5.8 BLADE TENSION ADJUSTMENT

Turn the blade tension hand wheel clockwise to increase blade tension. Tension should be just enough that blade does not slip on drive wheel while cutting. Do not apply excessive tension.

3.5.9 LEVELLING OF SAW BLADE AND BED HORIZONTAL LINE

- 1) Place a level on the bed (No. 4 in Fig. 10) to obtain the levelling, as shown in Fig. 10.
- 2) Loosen the lock nut (No. 3 in Fig. 10) and lower down the saw bow, then place the level on the top of saw blade (Fig. 10-A) to obtain the levelling of the bed horizontal line by adjusting the screw (No. 2 in Fig. 10).
- 3) Tighten the lock nut when levelling is obtained.

NOTE

If the saw blade top line is not levelled with the bed horizontal line, the workpiece can not be fully cut through.

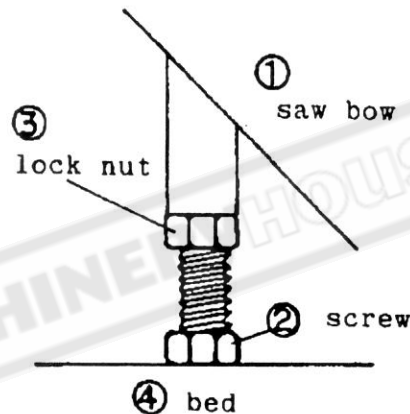

Fig. 10 Levelling of Saw Blade and Bed Horizontal Line

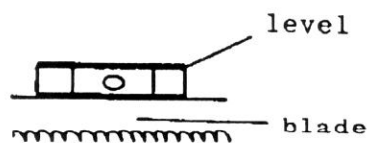

Fig. 10-A Saw Blade Levelling

3.5.10 AUTOMATIC SHUT-OFF

The motor should shut off immediately after the blade has cut through the material and just before the sawhead becomes resting on the horizontal stop screw.

If the motor can not shut-off automatically, then the horizontal stop screw must be adjusted.

- 1) Check the adjustment of horizontal stop screw. Please refer to 3.4.9.
- 2) Raise the sawhead and push the Band Saw Motor On Button.
- 3) Lower down the sawhead slowly and observe the actuation of the switch mechanism.

Section 4

ELECTRICAL SYSTEM

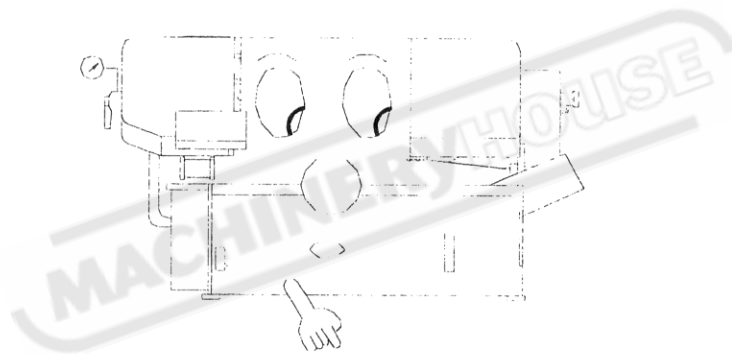

ELECTRICAL SYSTEM

Section 4

1. ALLOCATION:

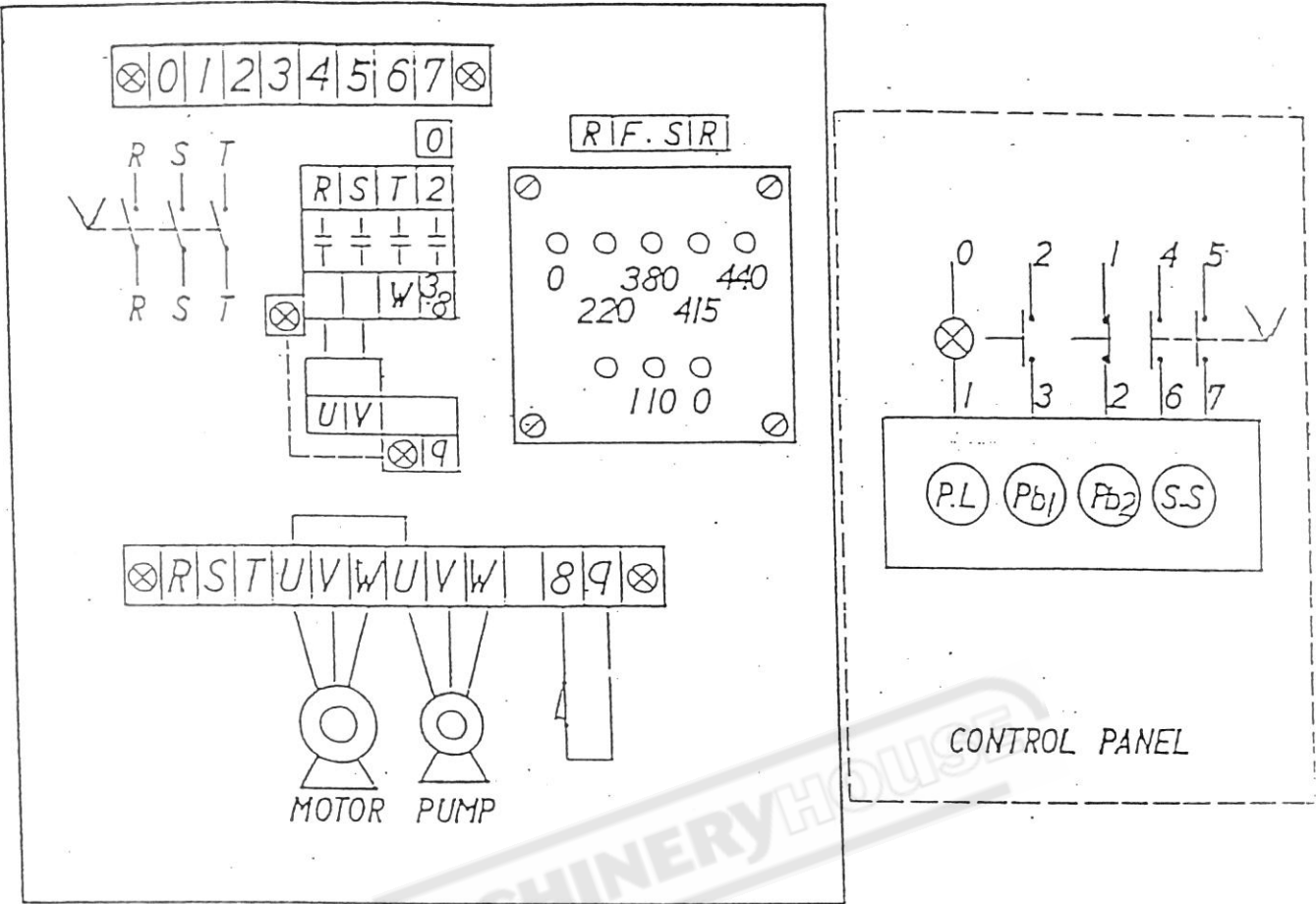

2. WIRING DIAGRAM

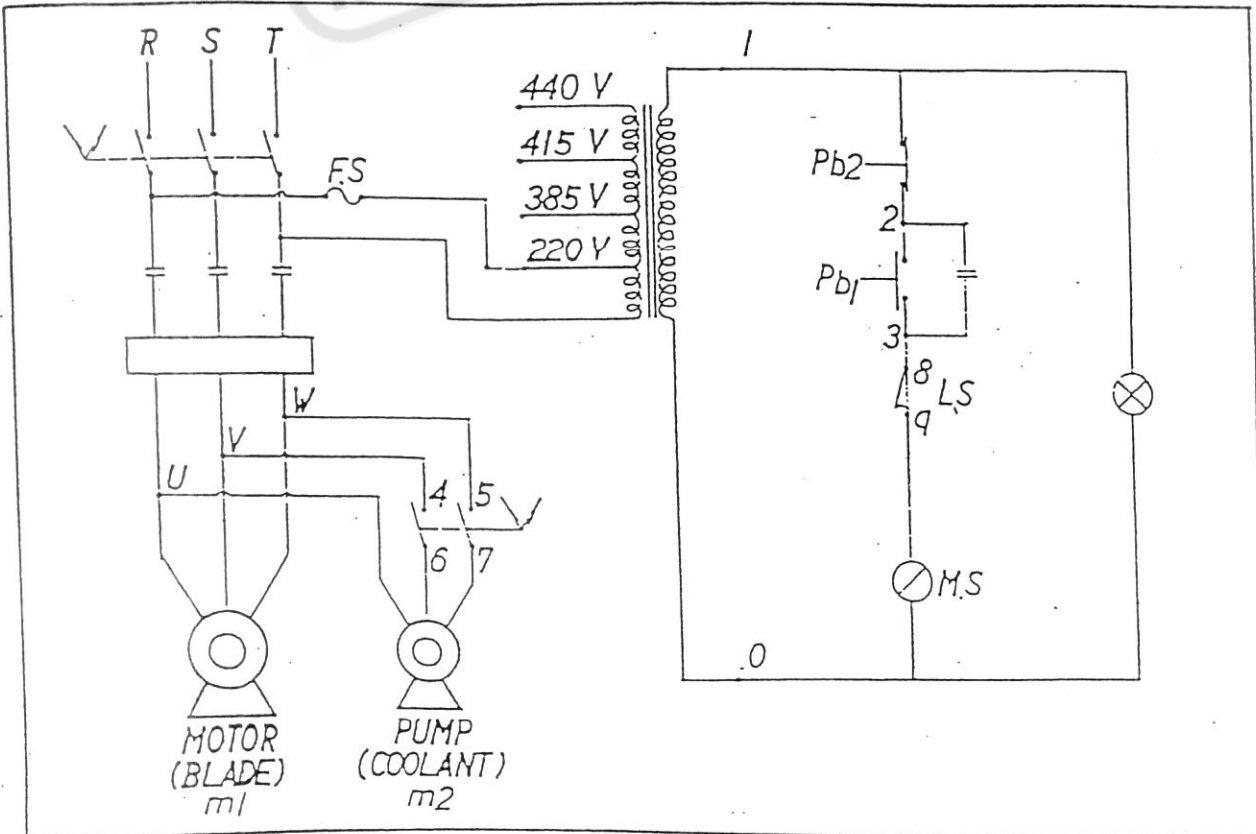

ELECTRICAL SYSTEM**Section 4**

SYMBOL	Q'TY	NAME	MAKER	TYPE
M1	1	motor	Tatung Co.	1.5 Kw, 4P
M2	1	motor	Hwang Yih	0.1 Kw, 4P-150
PT	1	transformer		P40VA
Pb1	1	push button	Yian kuang	YS-F1-3
Pb2	1	push button	Yian kuang	YS-L1-4
PL	1	pilot light	Shan ho	SP-251
SS	1	select switch	Shan ho	ST-251
MS	1	magnet switch	Tai an	HG11G 7A
PS	1	power switch	Kraus & Naimer	B9a292
FS	1	fuse		30L 1A
LS	1	Limit switch	Omron	D4MC-5000

The instructions to change wiring from 220 volt to 440 volt as follows:

1. Change main motor wiring to 440 volts per diagram inside motor cover.
2. Change wire on transformer from 220 volt tap to 440 volt tap.
3. Adjust main motor overload to 4 Amp.
4. Adjust hydraulic pump overload to 1A.
5. Change hydraulic pump motor wiring from 220 volt to 440 volt per diagram on inside of motor cover.
6. Change coolant pump motor wiring from 220 volt to 440 volt.

Section 5

HYDRAULIC SYSTEM

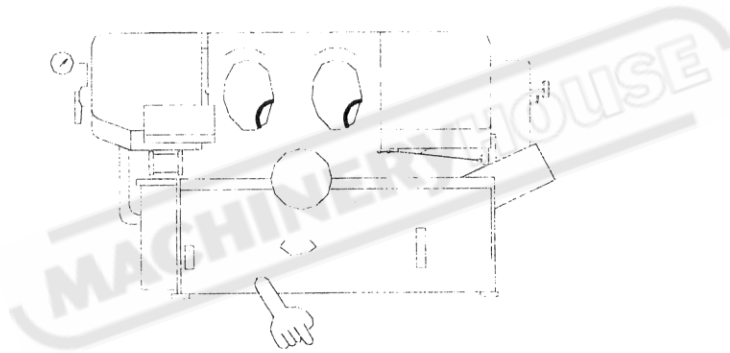

HYDRAULIC SYSTEM

Section 5

SECTION 5

HYDRAULIC SYSTEM

5.1 INTRODUCTION

The hydraulic system used in this semi-automatic bandsaw is very simple since the hydraulic force is used to lift the sawhead only. After rising to the top position, the sawhead can be held by turning the downfeed rate control dial to zero. By the way, the descending speed of the sawhead is also controlled by this flow control valve. In addition, a solenoid valve is used to control the moving direction of the lifting cylinder.

All of the hydraulic units are installed in the base cabinet so that the noise of the hydraulic units (i.e. hydraulic motor and pump) is isolated and then the machine performs quietly.

The hydraulic circuit of this system is shown in section 5.2 while the hydraulic layout is shown in section 5.3, both of them can help while considering the motion sequence of this machine.

Please refer to the hydraulic circuit and layout and disconnect all the powers before doing maintenance. COSEN or the local agent will supply the hydraulic components if needed.

HYDRAULIC SYSTEM

Section 5

5.2 THE LAYOUT OF THE HYDRAULIC SYSTEM

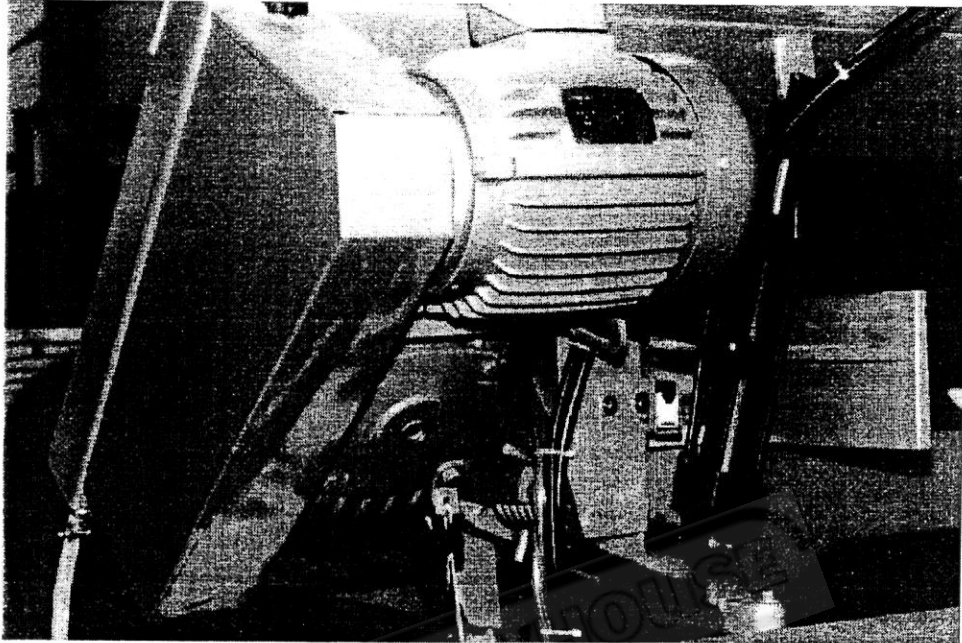

Fig. 5.1 The layout of the hydraulic system

5.3 THE HYDRAULIC CIRCUIT

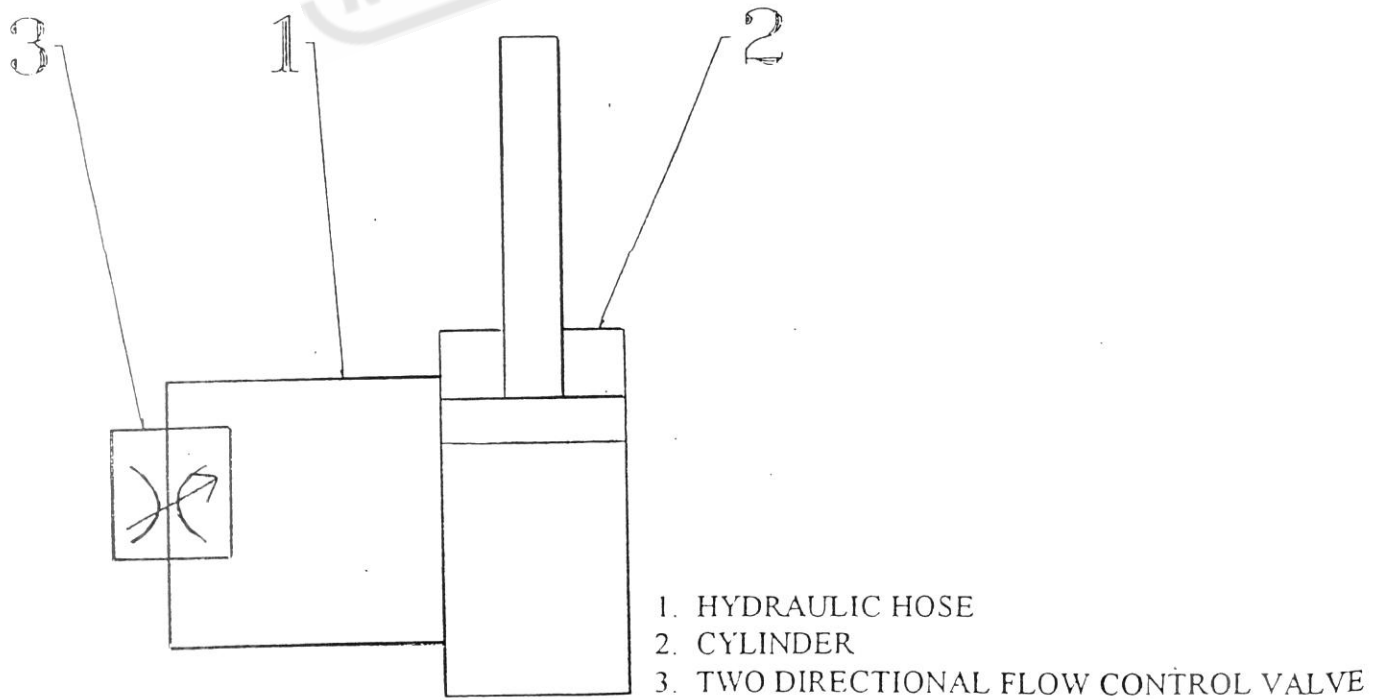
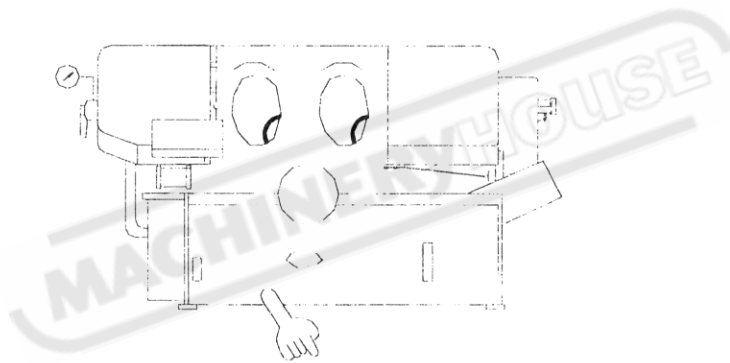

Fig. 5.2 The Hydraulic Circuit

Section 6

**BANDSAW CUTTING -
A PRACTICAL GUIDE**



BAND SAW CUTTING - A PRACTICAL GUIDE

Section 6

SECTION 6

BAND SAW CUTTING - A PRACTICAL GUIDE

6.1 INTRODUCTION

COSEN band saw machines are designed to be installed with high quality using high speed saw blades for maximizing productivity. To be able to use this kind of high performance band saw blade, the machine has to be of rugged design, have high quality saw blade guides, have sufficient motor horse power for high saw band speeds, and has to be able to apply necessary tension to the saw bands. Your COSEN machine has all these features to provide a better service for you.

The saw blade is guided through the cutting area by roller guides to keep it straight as it comes off the driving wheels. The precision carbide inserted guides then holds the blade securely and accurately throughout the sawing process. The tension of the saw blade is adjusted through the tensioning device on the strong saw bow. The cutting feed and down feed pressure of the blade is regulated automatically by hydraulic regulation.

6.2 BAND SAW BLADE SELECTION

The factors affecting cutting performance are:

- Type of material
- Material size and shape
- Guide spacing
- Blade selection
- Blade speed and feed
- Blade tension
- Blade vibration
- Coolant

Material and its relation to the cutting rate:

- Depending on the hardness of the material the cutting rate will increase or decrease. For example, it takes more time to cut stainless steel than to cut cast iron.
- The surface conditions will also affect the cutting rate. If there are places on the surface on the material which are hard, a slower blade speed will be required or blade damage may result.
- It will be slower to cut tubing than to cut solids, because the blade must enter the material twice, and because coolant will not follow the blade as well.
- Tough or abrasive materials are much harder to cut than their machinability rating would indicate.
- Tooth spacing is determined by the hardness of the material and its thickness in cross section.
- Tooth set prevents the blade from binding in the cut. It may be either a "regular set" (Also called a "Raker Set") or a "Wavy Set".

BAND SAW CUTTING - A PRACTICAL GUIDE

Section 6

- The regular or raker set is most common and consists of a pattern of one tooth to the left. Set to the right, to the left and one which is straight, or unset. This type of set is generally used where the material to be cut is uniform in size and for contour cutting.
- Wavy set has groups of teeth set alternately to right and left, forming a wave-like pattern. This reduces the stress on each individual tooth, making it suitable for cutting thin material or a variety of materials where blade changing is impractical. Wavy set is often used where tooth breakage is a problem. This is shown in Fig. 6.1 as follows:

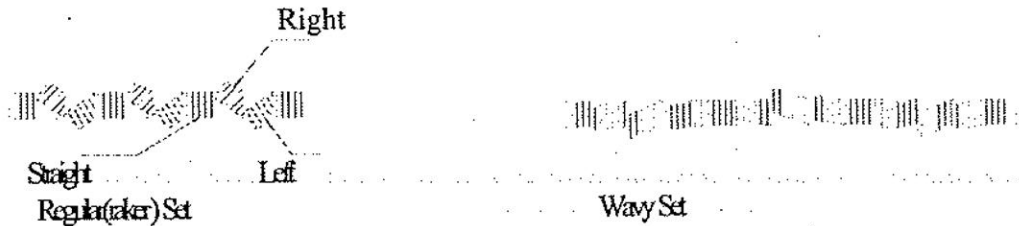

Fig. 6.1 The saw set

Blade Speed and Feed:

Blade speed is generally limited by vibration and the ability to keep the blade sufficiently cool to avoid dulling the teeth. A blade which is running fast and taking a very light cut will dull quickly because the tips of the teeth will overheat from the rubbing action. If, however, we force the blade teeth deeper into the material, the blade will be less sensitive to heat, because the teeth are cutting more and rubbing less.

Blade selection:

There are five types of blade material generally used:

- Hard-back carbon
- Semi-high speed
- High speed
- Carbon
- Electron-welded blade

In most high speed production cutting either the semi-high speed or the electron-welded band are used. Electron welded blade is the best blade. But it is also the most expensive. To construct the electron-welded blade, M-2 tool steel is welded to the blade back. Therefore the blade is capable of very high surface speed. The semi-high speed blade is used more in structural because it is capable of taking a great deal more abuse. The hard-back carbon blade's teeth does not have red-hardness but if the blade is run slowly it can be very economical. We do not recommend carbon blades because the back of the blade is not sufficiently strong to stand adequate tension and because it has poor resistance to heat and abrasion. Usually, the coarse hook tooth blade will give better results, but accurate feed control is a must with a coarse tooth blade.



Fig. 6.2 Electron Welded Blade

BAND SAW CUTTING - A PRACTICAL GUIDE

Section 6

A particular blade may have teeth which are too hard at the tips, causing them to break off in the material. This is most likely to happen as a result of chips wedging together in the cut. A broken tooth in the material can easily cause dulling on one side of the entire blade before it is dislodged from the cut.

Tooth Form and Spacing:

The selection of a tooth form generally is determined by the material to be cut. There are three general factors to consider: Tooth form, style or shape of the teeth; Tooth spacing, The number of teeth to the inch; and tooth set, which provides clearance for the body of the blade. Three styles of tooth are shown in Fig.6.3 below:

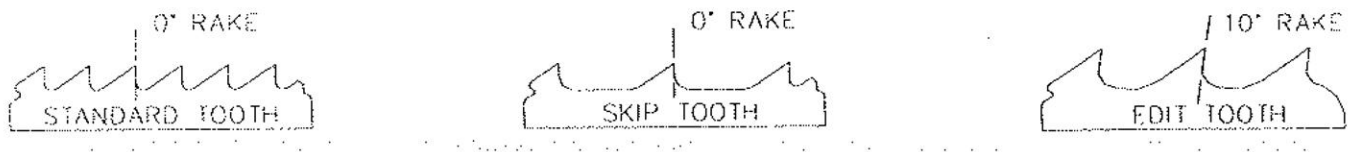

Fig. 6.3 Three styles of tooth

Material Size and Shape:

The optimum material width for a band saw blade is 1 inch wide by 0.35 thick and is about 5 inches long. Below this width tooth loading may become excessive and the cutting rate must be reduced. Above this width blade control begins to be lost, as discussed below. Since the blade "sees" only that material it is cutting, the shape of the stock being cut will also affect cutting speeds, particularly if the piece is excessively wide or if it varies in the dimensions being cut.

Guide Spacing:

The rigidity of the blade is a function of guide spacing, with rigidity being reduced to the third power as the distance between the guides increases. For example, with guides spaced 2 inches apart, blade deflection might be approximately 0.2. Under the same conditions, but with the guides spaced at 4 inches apart, blade deflection would be approximately 0.8.

This is a much simplified version of the formula, because it does not consider band tension or guide design. It is important to recognize, for example that rollers are considered as a pivotal contact. Whereas carbide faces could be considered as anchored supports. A more complete deviation, including band tension and guide design, is included in Roark's handbook, "Formula for stress and strain".

6.3 Some Sawing Practices

6.3.1. Selection of Saw Pitch :

Sawing "Rules of Thumb":

1. The thinner the stock, the finer the saw pitch
2. The thicker the stock, the coarser the saw pitch
3. The more difficult the stock, the finer the saw pitch
4. The softer the material , the coarser the saw pitch

Always have at least three teeth in contact with the material being cut.

BAND SAW CUTTING - A PRACTICAL GUIDE

Section 6

6.3.2. Material Size and Saw Pitch

Anytime during the cutting operation, at least three teeth must be in contact with the material being cut. Figure 6.4 shows some sawing practices:

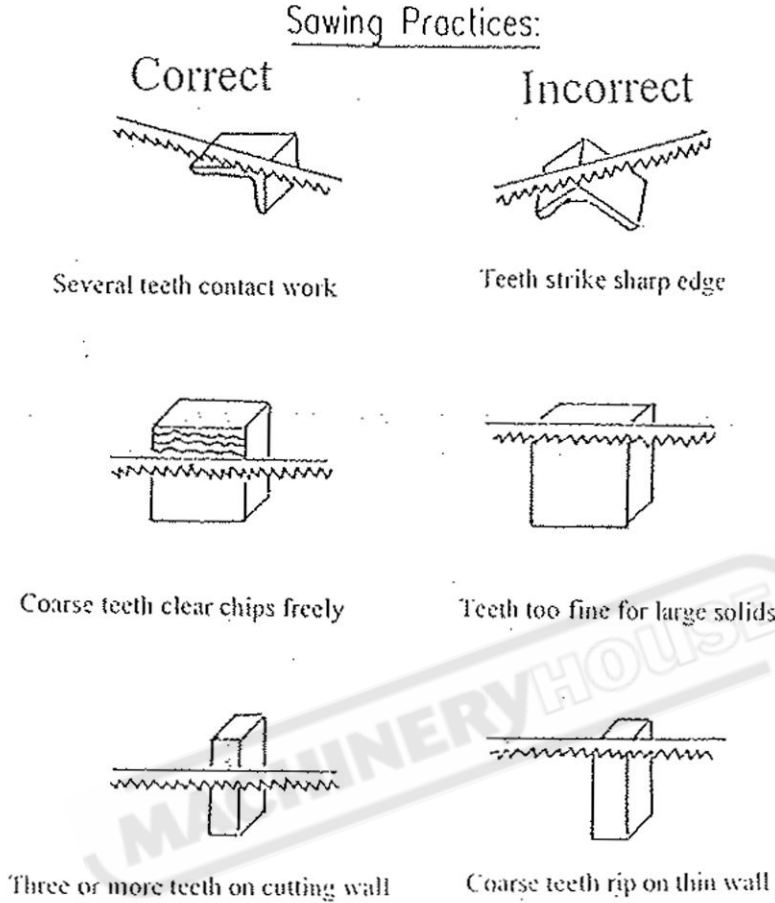
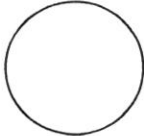



Fig. 6.4 Some sawing practices



Solid Stock:

				
up to 25 mm	- 1"	8-10 Teeth per inch(TPI)		
25-100mm	- 1"-4"	6-8 TPI		
100-250mm	- 4-10"	3-4 TPI		

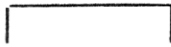

BAND SAW CUTTING - A PRACTICAL GUIDE

Section 6

Structurals:

up to 10 mm	- 3/8"		10-8 TPI		
10-20mm	- 3/8-3/4"		8-10 TPI		
above 20mm	- 3/4"		6-8 TPI		

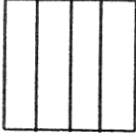
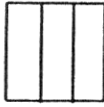
Solid:

up to 20mm	- 3/4"		8-10 TPI		
20-80mm	- 3/4-3.1/4"		2- 8 TPI		
above 80 mm	- 3.1/4"		4- 6 TPI		

You can refer to the feed and speed chart (Metric Table) as follows:



Section 7

MAINTENANCE

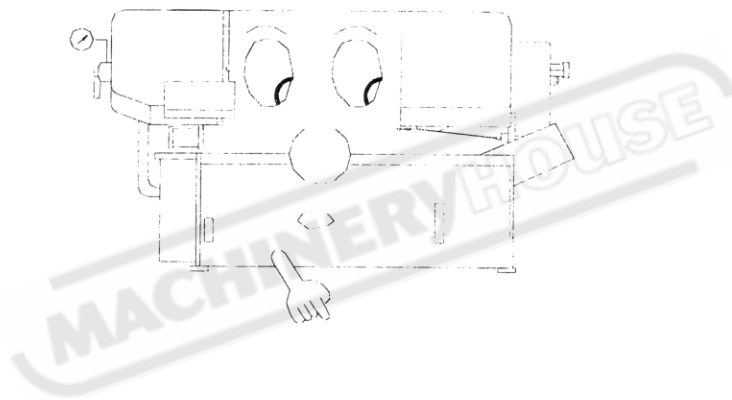

MAINTENANCE

Section 7

SECTION 7

MAINTENANCE

7.1 MAINTENANCE SCHEDULES

The four recommended schedules of maintenance are suggested below,

- A. DAILY maintenance
- B. MONTHLY maintenance
- C. FIRST THREE MONTH maintenance
(replacement of the transmission oil)
- D. EVERY HALF OF A YEAR maintenance

A. DAILY MAINTENANCE

⇒ **BEFORE WORK**

- ✓1. Check the hydraulic oil level.
- ✓2. Check the cutting fluid level and replace it if contaminated or deteriorated.
- ✓3. Check the saw blade to make sure that it is properly positioned on the bandwheels and clamped by the inserts.
- ✓4. Check the wire brush to ensure proper contact with the saw blade. Replace it if worn out.

⇒ **AFTER WORK**

- ✓1. Remove saw chips and clean the machine.
- ✓2. Lubricate following positions,
 - Surface of the bed

B. MONTHLY MAINTENANCE

Grease following points:

1. Bandwheels

2. Blade Tension Device

Recommended Grease Oil:

- * Shell Alvania EP Grease 2
- * Mobil Mobilplex 48

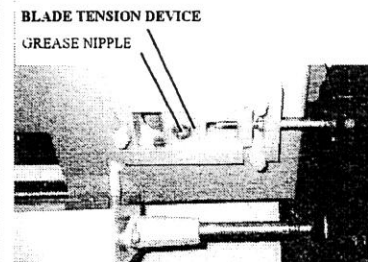
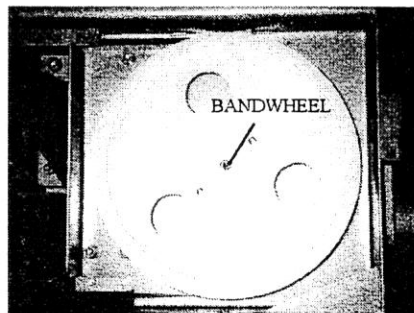

MAINTENANCE**Section 7****C. FIRST THREE MONTHS (TRANSMISSION OIL REPLACEMENT)**

Replace the transmission oil after operating for three months (or 600 hours).

Recommended Transmission Oil:

- * Shell Tellus 75
- * Mobil DTE Oil AA

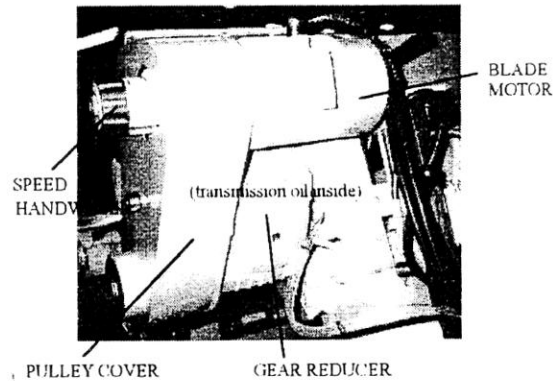
**D. EVERY HALF OF A YEAR MAINTENANCE**

- ✓1. Clean the filters of the cutting fluid.
- ✓2. Replace the transmission oil for every half of a year (or 1200 hours). Check the sight gauge to ascertain the transmission oil level.

Recommended TRANSMISSION OIL:

Shell Tellus 75

Mobil DTE Oil AA

- ✓3. Replace the hydraulic oil.

Recommended HYDRAULIC OIL:

Shell Tellus 27

Mobil DTE Oil Light Hydraulic 28

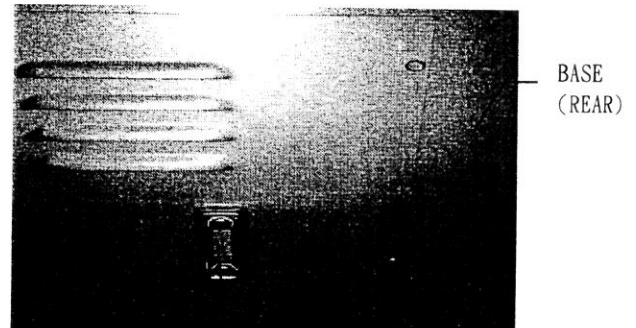
**7.2 STORAGE CONDITIONS OF THE MACHINE**

Your machine is supposed to be stored in the following conditions :

- (1) Disconnect power cord.
- (2) Ambient temperature: 5-40° C.
- (3) Relative humidity: 30%-95%.
- (4) Atmosphere: Use a plastic canvas to cover machine to avoid excessive dust, acid fume, corrosive gases and salt.
- (5) Avoid exposing to direct sunlight or heat rays.
- (6) Avoid exposing to abnormal vibration.

7.3 DISPOSAL OF THE MACHINE

Drain all of the cutting fluid and oil off and carefully treat them to avoid pollution.

Section 8

SYSTEMS TROUBLESHOOTING

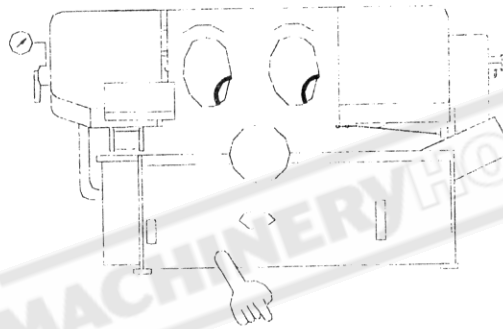

SYSTEMS TROUBLE SHOOTING

Section 8

SECTION 8

SYSTEMS TROUBLE SHOOTING

8.1 INTRODUCTION

All the machines being manufactured by COSEN pass a 72 hours continuously running test before shipping out and COSEN is responsible for the after sales service problems during the warranty period if the machine are used normally. However, there still exist the some unpredictable problems which may disable the machine from operating.

Generally speaking, the system troubles in this machine model can be classified into three types, namely GENERAL TROUBLES, MOTOR TROUBLES and BLADE TROUBLES. Although you may have other troubles which can not be recognized in advance, such as malfunctions due to the limited life-span of mechanical, electric or hydraulic parts of the machine.

As a twenty year old company, COSEN has accumulated enough experiences and technical data to handle all of the regular system troubles. Meanwhile, the engineering department of COSEN had been continuously improving the machines to prevent all possible troubles.

It is hoped that you will give COSEN your maintenance experience and ideas so that both sides can achieve the best performance.

SYSTEMS TROUBLE SHOOTING

Section 8

8.2 GENERAL TROUBLES AND SOLUTIONS

WARNING DISCONNECT POWER CORD TO MOTOR BEFORE
ATTEMPTING ANY REPAIR OR INSPECTION

TROUBLE	PROBABLE CAUSE	SUGGESTED REMEDY
Motor stalls	Excessive belt tension	Adjust belt tension so that belt does not slip on drive pulley while cutting (1/2" Min. deflection of belt under moderate pressure.)
	Excessive head pressure	Reduce head pressure. Refer to Operating Instructions "Adjusting Feed".
	Excessive blade speed	Refer to Operating Instructions "Speed Selection".
	Improper blade selection	Refer to Operating Instructions "Blade Selection".
Cannot make square cut	Dull blade	Replace blade.
	Guide rollers not adjusted properly	Refer to Adjustments.
	Rear vise jaw not adjusted properly	Set fixed vise jaw 90° to blade.
	Excessive head pressure	Reduce head pressure. Refer to operating instructions "Adjusting Feed."
Increased cutting time	Dull blade	Replace blade
	Insufficient head pressure	Increase head pressure. Refer to Operating Instructions "Adjusting Feed."
	Reduce blade speed	Refer to Operating Instructions "Speed Selection."
Will not cut	Motor running in wrong direction	Reverse rotation of motor (Motor rotation C.C.W. pulley end.)
	Blade teeth pointing in wrong direction	Remove blade, turn blade inside out. Re-install blade. (Teeth must point in direction of travel.)
	Hardened material	Use special alloy blades (Consult your Industrial Distributor for recommendation on type of blade required.)

SYSTEMS TROUBLE SHOOTING

Section 8

8.3 MOTOR TROUBLES AND SOLUTIONS

TROUBLE	PROBABLE CAUSE	SUGGESTED REMEDY
Motor will not start	Magnetic switch open, or protector open.	Reset protector by pushing red button (inside electric box.)
	Low voltage	Check power line for proper voltage.
	Open circuit in motor or loose connections.	Inspect all lead terminations on motor for loose or open connections.
Motor will not start, fuse or circuit breakers "blow".	Short circuit in line, cord or plug.	Inspect line, cord and plug for damaged insulation and shorted wire.
	Short circuit in motor or loose connections	Inspect all lead terminations on motor for loose or shorted terminals or worn insulation on wires.
	Incorrect fuses or circuit breakers in power line.	Install correct fuses or circuit breakers.
Motor fail to develop full power. (Power output of motor decreases rapidly w/decrease in voltage at motor terminals.)	Power line overloaded with lights, appliances and other motors.	Reduce the load on the power line.
	Undersize wires or circuit too long.	Increase wire sizes, or reduce length of wiring
	General overloading of power company's facilities.	Request a voltage check from the power company
Motor overheat	Motor overloaded.	Reduce load on motor
	Air circulation through the motor restricted.	Clean out motor to provide normal air circulation through motor.
Motor stalls (Resulting in blown fuses or tripped circuit breakers)	Short circuit in motor or loose connections.	Inspect terminals in motor for loose or shorted terminals or worn insulation on lead wires.
	Low voltage	Correct the low line voltage conditions.
	Incorrect fuses or circuit breakers in power line.	Install correct fuses circuit breakers.
	Motor overloaded	Reduce motor load.
Frequent opening of fuses or circuit breakers.	Motor overloaded	Reduce motor load
	Incorrect fuses or circuit breakers.	Install correct fuses or circuit breakers.

SYSTEMS TROUBLE SHOOTING

Section 8

8.4 BLADE TROUBLES AND SOLUTIONS

WARNING DISCONNECT POWER CORD TO MOTOR BEFORE
ATTEMPTING ANY REPAIR OR INSPECTION

TROUBLE	PROBABLE CAUSE	SUGGESTED REMEDY
Teeth strippage	Too few teeth per inch	Use finer tooth blade
	Loading of gullets	Use coarse tooth blade or cutting lubricant.
	Excessive feed	Decrease feed
	Work not secured in vise	Clamp material securely
Blade breakage	Teeth too coarse	Use a finer tooth blade
	Misalignment of guides	Adjust saw guides
	Dry cutting	Use cutting lubricant
	Excessive speed	Lower speed. See Operating Instructions "Speed selection."
	Excessive speed	Reduce feed pressure. Refer to Operating Instructions "Adjusting Feed."
	Excessive tension	Tension blade to prevent slippage on drive wheel while cutting.
Run-out and Run-in	Wheels out of line	Adjust wheels
	Guides out of line	For a straight and true cut, realign guides, check bearings for wear.
	Excessive pressure	Conservative pressure assures long blade life and clean straight cuts.
	Support of blade insufficient	Move saw guides as close to work as possible.
	Material not properly secured in vise	Clamp material in vise, level and securely.
Blade twisting	Blade tension improper	Loosen or tighten tension on blade.
	Blade not in line with guide bearings	Check bearings for wear and alignment.
	Excessive blade pressure	Decrease pressure and blade tension
Premature tooth wear	Blade binding in cut	Decrease feed pressure
	Dry cutting	Use lubricant on all materials, except cast iron
	Blade too coarse	Use finer tooth blade
	Not enough feed	Increase feed so that blade does not ride in cut
	Excessive speed	Decrease speed

Section 9

PARTS LIST

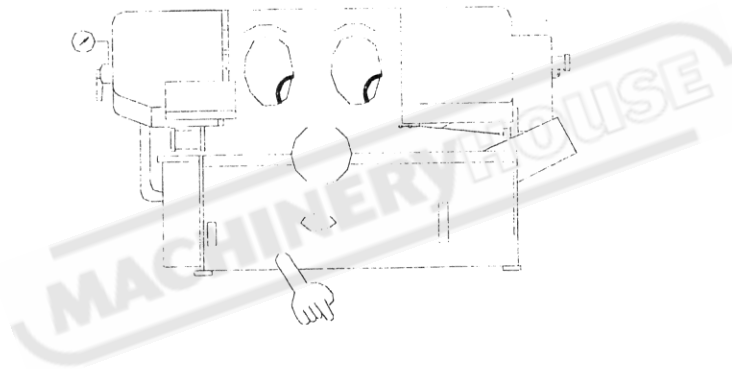

1. SAW BOW

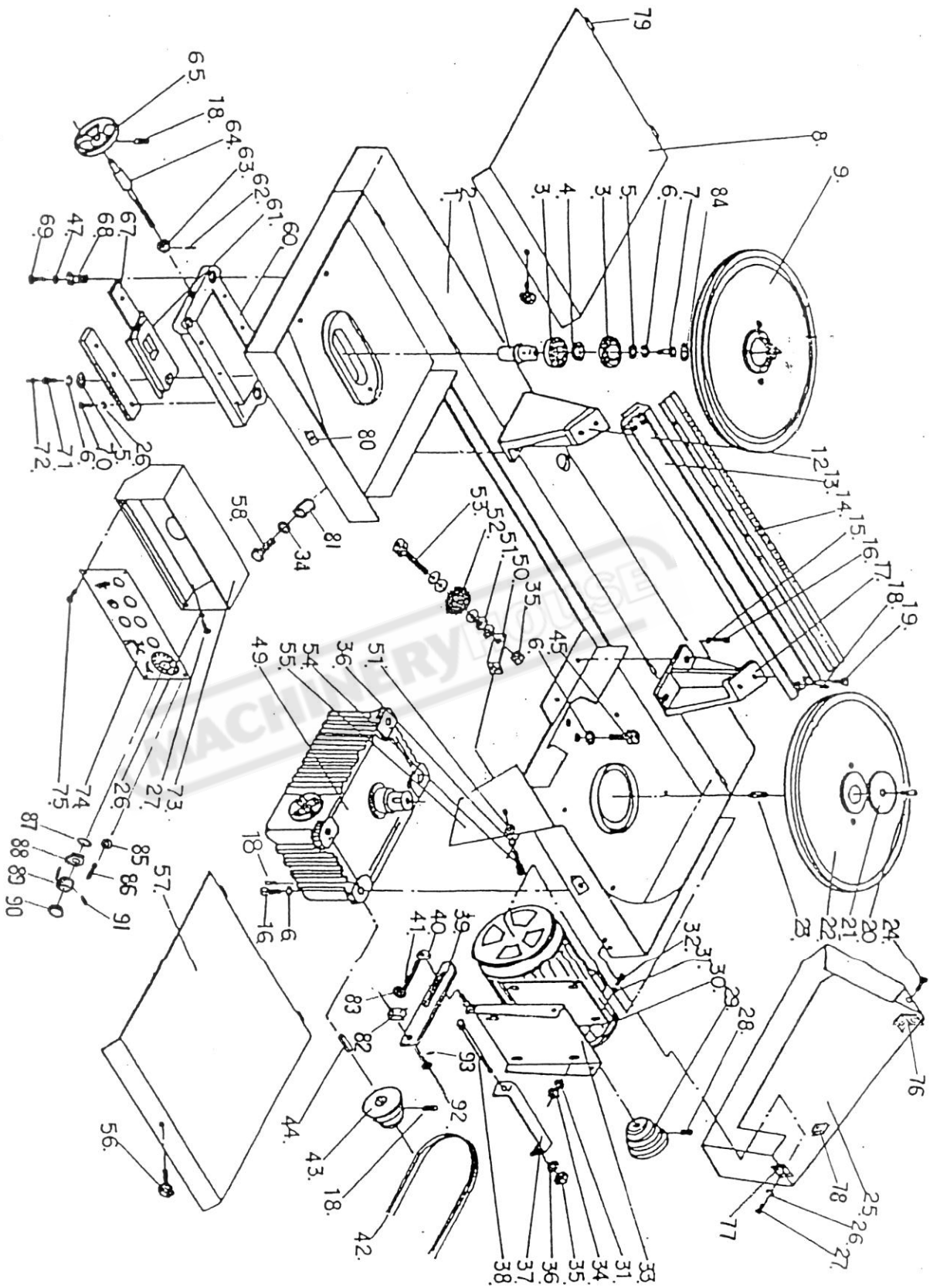

CHART 1 SAW BOW

NO.	PART NO.	PART NAME	PART NAME IN CHINESE	PART SPEC.	Q'TY
1	SYM-5001	Saw bow	弓鋸頭		1
2	SJY-1114	Idle wheel shaft	上輪軸		1
3	PP-14130	Bearing	軸承	6205Z	2
4	MAE-2025	Bearing washer	上輪軸墊圈		1
5		Washer	平面華司	M12	2
6		Spring washer	彈簧華司	M12	12
7		Bolt	外六角螺絲	M12*20L	1
8	MJA-2014	Wheel cover (left)	上下輪箱蓋		1
9	MJA-2017A	Idle wheel	上輪		1
10				DELETED	
11				DELETED	
12	SYM-5003	Bracket (left)	左鋸臂滑板固定座		1
13	SJY-1105	Dovetail guide	鋸臂滑板		1
14	MJA-2044	Gauge plate (ruler)	銘板	CS-5	1
15		Spring washer	彈簧華司	M12	4
16		Bolt	內六角螺絲	M12*30L	8
17	SYM-5004	Bracket (right)	右鋸臂滑板固定座		1
18		Set screw	止付螺絲	M8*20L	10
19		Screw	內六角螺絲	M10*30L	4
20		Screw	內六角螺絲	5/16*3/4	1
21	MJA-2013	Washer (B)	下輪軸蓋		1
22	SJY-1118	Drive wheel	下輪		1
23		Key	鍵	10*8*20 mm	1
24	PP-53021	Screw	梅花螺絲	M6*12L	1
25	MJA-2008C	Pulley cover	皮帶輪護蓋		1
26		Spring washer	彈簧華司	M6	14
27		Screw	丸頭螺絲	M6*12L	8
28		Set screw	止付螺絲	M8*10L	1
29	SJY-1119	Motor pulley	馬達普利		1
30	PP-31041	Motor	馬達	2HP,4P	1
31		Washer	彈簧華司	M10	8
32		Screw	外六角螺絲	M10*25L	5
33	MJA-2067	Motor mounting plat	馬達底板		1
34		Nut	螺帽	M10	6
35		Nut	螺帽	M8	2
36		Spring washer	彈簧華司	M8	2
37	MJA-2069A	Bracket	馬達調整架		1
38	MJA-2072	Lock screw	馬達架螺絲		1
39	MJA-2068	Adjusting plate	馬達調整板		1
40	SJY-1127	Lock nut	固定螺母		1
41	SJY-1126	Lever	馬達調整固定把手		1
42	PP-56100	V Belt	皮帶	A-39	1
43	MJA-2011C	Transmission pulley	減速機皮帶輪		1
44		Key	鍵	7*7*25 mm	1
45		Bolt	內六角螺絲	M12*40L	6
46				DELETED	

CHART 1 SAW BOW

NO.	PART NO.	PART NAME	PART NAME IN CHINESE	PART SPEC.	Q'TY
47		Spring washer	彈簧華司	M10	3
48				DEL	
49	PP-16022	Gear box	減速機	70#	1
50	SJY-1136	Bracket	鋼刷固定板		1
51		Washer	平面華司	M8	6
52	PP-58002	Wire brush	鋼刷	90*8 mm #0.3	1
53		Screw	有頭螺絲	M8*30L	1
54		Screw	有頭螺絲	M8*12L	1
55	MAM-2041	Wire brush cover	鋼刷護蓋		1
56	PP-53030	Knob	梅花螺絲	1/4*3/4"	2
57	MJA-2014	Wheel cover (right)	上下輪箱蓋		1
58		Screw	外六角螺絲	M10*25L	1
59				DELETED	
60	SJY-11029	Tension plate	張力調整滑座		1
61	SJY-11029	Adjusting slide	張力調整板		1
62		Spring pin	彈簧銷	φ 3*25L	1
63	MJA-2024	Collar	張力調整固定圈		1
64	SJY-1115	Blade tensioning scr	張力調整螺桿		1
65	SJY-1103	Hand wheel	手輪		1
66				DELETED	
67	SJY-11029	Guide plate	壓條(半)		2
68	SJY-1104	Adjusting bolt	張力調整螺絲	M16*40L	3
69		Screw	外六角螺絲	M10*50L	3
70		Screw	外六角螺絲	M6*20L	6
71	SJY-1150	Nipple	關節油嘴		1
72		Nipple	油嘴	1/16"	1
73	MJA-4005-CE	Control box	控制箱		1
74	MJA-4005C	Control panel	控制面板		1
75		Screw	圓頭螺絲	M4*5L	6
76	KM-2012	Bracket	輪箱蓋固定板		1
77	MAE-2027B	Hinge	鉸鏈		1
78	SJY-1120	Bracket	護蓋固定板		1
79	MJA-1004	Pin	箱蓋栓		4
80	MJA-2054	Bracket	輪蓋固定板		2
81	SJY-1128	Bracket	鋸弓定位塊		1
82	MJA-2070	Adjusting plate	馬達調整塊		1
83	PP-52040	Plastic ball	塑膠球	3/8"	1
84		Snap ring	扣環	R52	2
85		Nut	螺母	M4	1
86	SJY-2108	Pointer rod	指針擋桿		1
87		Washer	平面華司	φ 16	1
88	MAJ-4010	Nut	六角螺帽		1
89	MAJ-4007	Pointer & Bracket	指針及座		1
90	PP-21010	Knob	旋鈕		1
91		Screw	丸頭螺絲	3/16*3/8"	1
92	MJA-2073	Adjusting nut	調整螺母		1

CHART 1 SAW BOW

NO.	PART NO.	PART NAME	PART NAME IN CHINESE	PART SPEC.	Q'TY
93		Pin	開口梢	5/32*1 1/4	1
94					
95					
96					
97					
98					
99					
100					
101					
102					
103					
104					
105					
106					
107					
108					
109					
110					
111					
112					
113					
114					
115					
116					
117					
118					
119					
120					
121					
122					
123					
124					
125					
126					
127					
128					
129					
130					
131					
132					
133					
134					
135					
136					
137					
138					

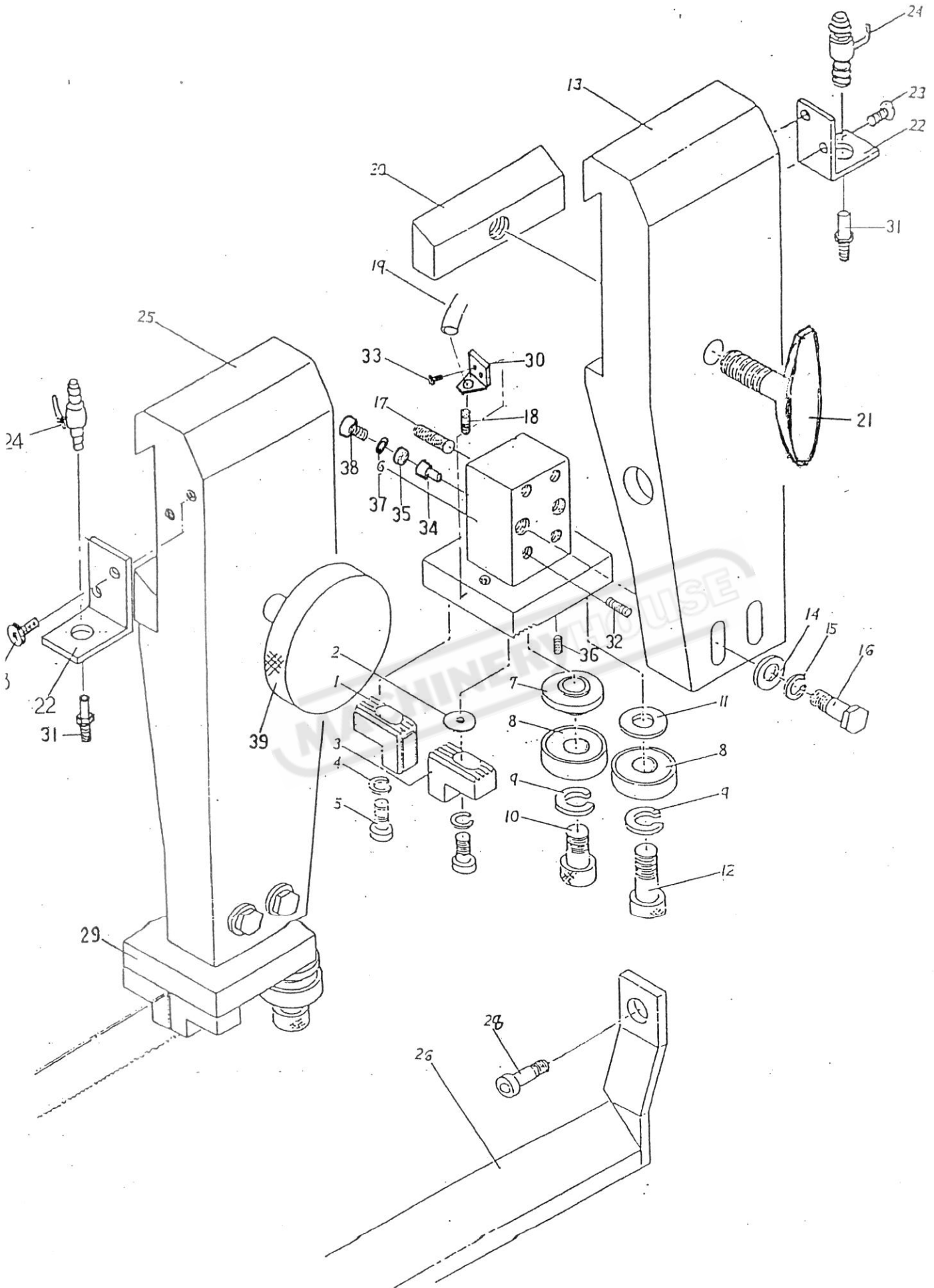

CHART 2 BLADE GUADE ARMS

NO.	PART NO.	PART NAME	PART NAME IN CHINESE	PART SPEC.	Q'TY
1	MAB-6006	Tungsten carbide blade guide	鋸片固定塊		2
2				DELETED	
3	MAB-6006	Tungsten carbide blade guide	鋸片固定塊		2
4		Spring washer	彈簧華司	M16	4
5		Bolt	內六角螺絲	M6*25L	4
6	SJY-1111	Guide seat	右導輪座		1
7	MAB-6008	Washer	華司		2
8		Bearing	軸承	6202 ZZ	4
9		Spring washer	彈簧華司	M10	4
10		Bolt	內六角螺絲	M10*38L	2
11		Washer	華司	M10	2
12		Bolt	內六角螺絲	M10*25L	2
13	SYM-8006	Guide arm (right)	右鋸臂		1
14		Washer	華司	M8	4
15		Spring washer	彈簧華司	M8	4
16		Bolt	內六角螺絲	M8*32L	4
17		Screw	止付螺絲	M6*12L	4
18	MAB-6014	Fitting	水管接頭固定塊		2
19		Hose	水管	1/4*3000L	2
20	MJA-2032	Clamping block	鋸臂固定塊		2
21	MJA-2031	Knob	鋸臂把手		1
22	MJA-2041	Bracket	水龍頭座板		2
23		Screw	有頭螺絲	M5*10L	4
24	PP-43132	Coolant valve	開關閥	1/8"	2
25	SYM-8005	Guide arm (left)	左鋸臂		1
26	MJA-2038	Blade guard	鋸臂護蓋		1
27				DELETED	
28		Screw	內六角螺絲	M6*10L	1
29	SJY-1110	Guide seat (left)	左導輪座		1
30	SJY-1134	Bracket	水龍頭固定板		2
31	MJA-2043	Fitting	水管接頭		2
32		Set screw	止付螺絲	M8*16L	2
33		Screw	內六角螺絲	M5*10L	4
34	SJY-1112	Bearing shaft	下壓固定軸		2
35	PP-14211	Bearing	軸承	608 VV	2
36		Set screw	止付螺絲	M6*6L	2
37		Washer	平面華司	M4	2
38		Screw	丸頭螺絲	M4*6L	2
39		Bolt	外六角螺絲	1/2-20UNC*2 1/4	1
40					
41					
42					
43					
44					
45					
46					

CHART 3 BASE ASSEMBLY AND BED

NO.	PART NO.	PART NAME	PART NAME IN CHINESE	PART SPEC.	Q'TY
1	MAM-1001-CE	Base	底座		1
2	SJY-1149B	Lead screw nut	導桿螺母		1
3	SYM-6017A	Bed	床面		1
4		Spring washer	彈簧華司	M10	4
5		Bolt	外六角螺絲	M10*25L	2
6	MJA-2012A	Screw sleeve	導螺桿座		1
7		Screw	外六角螺絲	M6*12L	6
8		Pump cover	幫浦護蓋		1
9		Screw	外六角螺絲	M6*20L	4
10	PP-32041	Pump	浸水幫浦	1/8HP,3φ,150L	1
11					
12	PP-52030	Handle	手輪柄	3/8"	1
13	PP-52020	Hand wheel	手輪	6", 20φ	1
14	MJA-1013	Collar	導輪桿固定圈		1
15		Spring pin	彈簧銷	φ 6*30L	1
16	MJA-1014	Vise lead screw	導輪桿		1
17		Snap ring	扣環	A25	1
18	MAM-2032	Cylinder pivot	油壓缸活動軸		1
19	SJY-1151	Movable vise jaw	活動虎鉗		1
20	MJA-1035-CE	Cylinder	油壓缸		1
21		Screw	丸頭螺絲	M6*12L	2
22		Screw	丸頭螺絲	M5*25L	2
23	PP-90010	Limit switch	限動開關	D4MC-5000	1
24	MJA-3102-CE	Switch bracket	限動開關座		1
25				DELETED	
26		Cotter pin	開口銷	5/32*1 1/4"	1
27	MAE-1032	Hinge shaft	油壓缸短插梢		1
28				DELETED	
29	MJA-1024	Depth bar	定寸桿	DELETED	1
30		Washer	平面華司	M12	3
31		Spring washer	彈簧華司	M12	4
32		Bolt	外六角螺絲	M12*48L	4
33	SYM-6002	Fixed vise jaw	固定虎鉗		1
34				DELETED	
35				DELETED	
36				DELETED	
37		Screw	皿頭內六角螺絲	M5*12L	4
38	MAE-5010	Plate	關節座蓋板		1
39	SYM-5002B	Saw bow bracket	關節座		1
40		Set screw	止付螺絲	M6*12L	2
41	SYM-6007	Pivot	關節軸		1
42	PP-13190	Needle bearing	乾式軸承	3015	2
43	MJM-5006B	Spring	回程彈簧		1
44				DELETED	
45				DELETED	
46				DELETED	

CHART 3 BASE ASSEMBLY AND BED

NO.	PART NO.	PART NAME	PART NAME IN CHINESE	PART SPEC.	Q'TY
47	MBR-9037	Stopper	定寸擋桿		1
48	PP-53009	Lock bolt	梅花螺絲	M10*30L	2
49	MBR-9036	Stopper bracket	定寸滑座		1
50	SYM-6011	Pivot	定寸轉軸		1
51		Screw	外六角螺絲	M8*20L	6
52		Spring washer	彈簧華司	M8	6
53	MAM-1010		定寸座		1
54	MAM-1011		托架		1
55				DELETED	
56				DELETED	
57				DELETED	
58				DELETED	
59				DELETED	
60				DELETED	
61				DELETED	
62	SYM-6008	Turning slide	旋轉軌道 A		1
63	SYM-6009	Turning slide	旋轉軌道 B		1
64		Plug	塞頭	PT 1/2	1
65				DELETED	
66				DELETED	
67				DELETED	
68				DELETED	
69				DELETED	
70				DELETED	
71		Screw	內六角螺絲	M8*20L	1
72	MAE-1033	Bracket	彈簧調整板		1
73	MAE-1039B	Spring	彈簧		1
74	MAM-1034	Bracket	調整板座		1
75		Screw	內六角螺絲	M8*25L	1
76	MLA-1010	Washer	耐磨墊圈		2
77	SYM-5008	Plate	關節墊圈壓板		1
78		Nut	六角螺母	M8	1
79	SYM-6019	Bracket	定位板		2
80		Nut	螺母	M10	2
81		Screw	外六角螺絲	M10*40L	2
82	MJA-1028B	Bracket	油壓缸固定耳		1
83	SYM-6020	Screw	銷螺絲		1
84		Set screw	止付螺絲	M8*16	4
85	PP-13170	Bearing	乾式軸承	2820	2
86	SYM-6013	Rotate shaft	旋轉軸		1
87	SYM-6012	Bracket	旋轉軸固定座		1
88				DELETED	
89		Screw	外六角螺絲	M10*20	2
90	SYM-6014	Fixed nut	固定螺母		2
91					
92					

Reference

APPENDIX

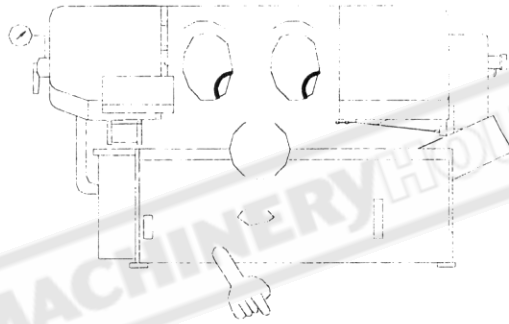

REFERENCE**Appendix****APPENDIX A****SPECIFICATIONS OF THE MACHINE**

MODEL		MH-1016JA, Manual Band Saw Machine	
MAX. CAPACITY		●(D)	250 mm (10", 90°) 250 mm (45°)
		■ (W × H)	230 × 230 mm (9" × 9", 90°) 150 × 150mm(45°)
		■(W × H)	230 × 400 mm (9" × 16", 90°) 150 × 230mm(45°)
SAW BLADE	SPEED	60Hz	23,37,58,93 m/min. (75~305 fpm)
		50Hz	19,31,45,67 m/min. (62~256 fpm)
	SIZE (W × L × T)	3350 × 25 × 0.9 mm (132" × 1" × 0.035")	
MOTOR OUTPUT		SAW BLADE	1.5 kW (2HP)
		COOLANT	0.1 kW (1/8HP)
COOLANT		CAPACITY	20 L (5.28 gal. U.S. standard)
FEEDING		MODE	MANUAL
		LENGTH	0-3600 mm (0 ~ 141")
WISE	CONTROL METHOD	STATIONARY & MOVABLE MANUAL VISE	
HEIGHT OF WORK BED		620 MM (24.5")	
NET WEIGHT		600 kgs (1320 lbs)	
GROSS WEIGHT		650 kgs (1430 lbs)	
FLOOR SPACE(L × W × H)		1690 × 830 × 710 mm (66.5" × 32.7" × 28")	
		●Adding width is 1000 or 2000 mm more (with the optional roller table, high 620mm)	
		●The height is 710 mm when saw bow is at horizontal position	
SHIPPING SPACE (L × W × H)		1816 × 1003 × 1168 mm (71.5" × 39.5" × 46")	

* Design and specifications are subjected to change without notice

REFERENCE
Appendix

APPENDIX B

FOUNDATION DIAGRAM

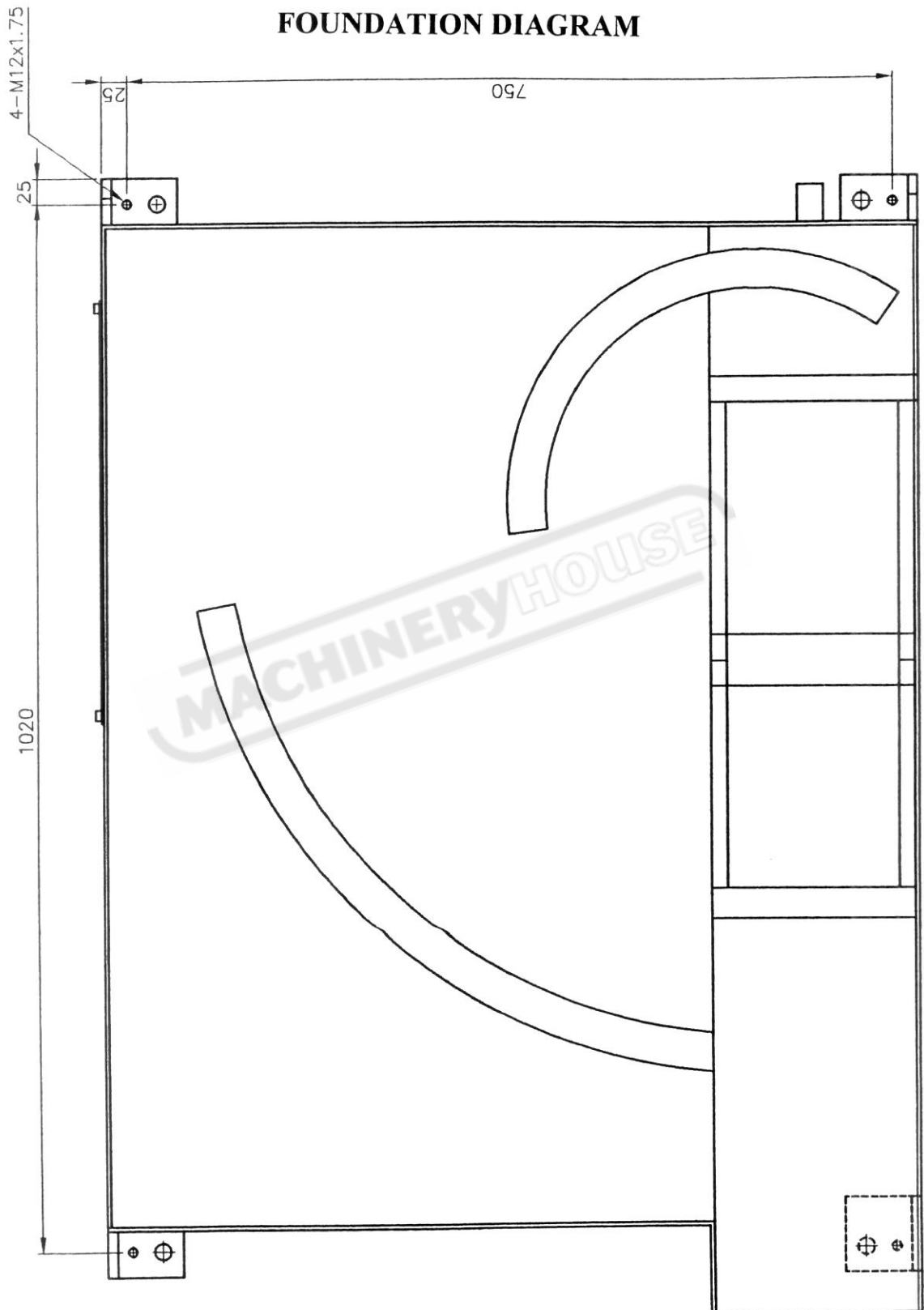

REFERENCE**Appendix****APPENDIX C****ACCESSORIES OF THE MACHINE****I. STANDARD ACCESSORIES:**

NAME	QUANTITY	UNIT	SPECIFICATION
Adjustable material stop	1	set	
Chip brush	1	pc.	
Cleaning Gun	1	pc.	
Complete coolant system	1	pc.	
Nesting fixture (vertical clamping)	1	set	
Operation manual & parts list	1	pc.	
Saw blade	1	pc.	
Tool box with tools	1	pc.	



Please call dealer for ordering the following items:

II. OPTIONAL ACCESSORIES

NAME	QUANTITY	UNIT	SPECIFICATION
Additional saw blade		pc	3350L × 25W × 0.9T
Additional chip brushes		pc	
Clamping device for short piece		set	
Non step variable speed device		set	
Roller table		set	1 M or 2 M
Vertical clamping roller		set	

APPENDIX D

MAINTENANCE SCHEDULE



Before beginning work each day

- ✦ Please check the hydraulic oil level, add oil as necessary.(middle level is better)
- ✦ Please check the cutting fluid level, add fluid as necessary. If the fluid appears contaminated or deteriorated, drain and replace it.
- ✦ Please check the saw blade to ensure that it is properly positioned on both the drive and driven wheels.
- ✦ Please make sure that the saw blade is properly clamped by the left and right inserts (blade guides).
- ✦ Please check the wire brush for proper contact with the saw blade. Replace the wire brush if it is worn.

Before ending day's work

- ◇ Please remove saw chips and clean the machine when discharging the cutting fluid and when work has been completed.
 - When cutting fluid is being discharged during saw blade operation, please follow the safety method carefully. Otherwise, it will greatly increase your chance of hand injury.
- ◇ Lubricate the following items:

• Front vise slide plates	• Rigid column
• Rear vise slide plates	• Quick approach device
• Feed cylinder guide shafts	• Rear vise guide bars

Once every month

Please apply grease to the following items:

- ◆ Drive wheel
- ◆ Driven wheel
- ◆ Blade tension device
- ◆ Worm shaft

Recommended Grease:

Shell Alvania EP Grease 2
Mobil Mobilplex 48

Once every six months

- ◆ Please clean the filters in the cutting fluid tank.
- ◆ Please replace the transmission oil after the first three months (or 600 hours of operation) Thereafter, every six months (or every 1200 hours of operation), whichever occurs first. Check the sight gauge to ascertain the transmission oil level.

Recommended Oil:

Shell Tellus 75
Mobil Mobilplex 48

- ◆ Replace the hydraulic oil.

Recommended Oil:

Shell Tellus 27, Mobil DTE Oil Light Hydraulic 28.